



SUNNY BOY STORAGE

Approved batteries and information on connecting batteries

Approved automatic transfer switching devices for battery-backup operation

1 SBS2.5-1VL-10

1.1 Approved batteries for SB2.5-1VL-10

i Firmware version of the battery

The firmware version of the battery can be accessed via the user interface of the inverter. The firmware version of the BYD batteries can also be accessed via the user interface of the battery (see manufacturer's manual). With the exception of the BYD Battery-Box (H and Premium HVS), the battery firmware is automatically updated via the inverter.

i Inverter firmware version

The firmware version of the inverter can be accessed via the user interface of the inverter.

Type (manufacturer)	Modules	Firmware version of the battery:	Firmware version of the inverter:
Battery-Box H 5.1-10.2 (BYD Company Limited)	4-8	3.00.04.R to 3.00.15.R	≥ 2.04.23.R
Battery-Box Premium HVS 5.1-10.2 ¹⁾ (BYD Company Limited)	2-4	BMU ≥ 3.13 BMS ≥ 3.19	≥ 3.11.06.R
RESU 7H / EH111063P3S3 Type C (LG Energy Solution)	Not modular	≥ 15.02.4.R	≥ 2.04.23.R
RESU 10H / 15563P3SDLT Type C (LG Energy Solution)	Not modular	≥ 13.13.0.R	≥ 2.04.14.R

Synchronizing the battery and battery inverter

All batteries mentioned supply a defined nominal current. Please pay attention to the battery manufacturer's recommendation regarding the suitable dimensioning of the battery in order to achieve the nominal and overload currents of the systems stated in the datasheet with a Sunny Boy Storage. Only if the dimensioning of the battery size is synchronized (battery capacity, battery currents, number of battery modules if necessary), the full functionality and power incl. overload can be guaranteed for the PV storage system with the respective battery inverter in use.

¹⁾ When using the BYD Battery-Box Premium HVS with the Sunny Boy Storage 2.5, you must select the Sunny Boy Storage 2.5 inverter during configuration. Observe the information on the current Sunny Boy Storage 2.5 firmware package in the readme file in the download area at www.SMA-Solar.com.

1.2 Overview of the recommended systems for SBS2.-1VL-10

Battery type (module configuration)	Use in systems for/with		
	Optimization of self-consumption	Secure power supply operation	Battery-backup operation
Battery-Box H (5.1 - 10.2)	✓	✗	✗
Battery-Box Premium HVS (5.1-10.2)	✓	✗	✗
RESU 7H type C	✓	✗	✗
RESU 10H type C	✓	✗	✗

✓ = Yes, ✗ = No

1.3 Battery Communication Connection

1.3.1 Battery data cable requirements for SBS2.5-1VL-10

- Twisted pair conductors
- Cable category: minimum CAT5e
- Cable with shielding: Yes
- Conductor cross-section: 0.25 mm² to 0.34 mm² (24 AWG to 16 AWG)
- Recommended number of conductor pairs: 4
- Maximum cable length: 10 m (33 ft)
- The cable has to be insulated for 600 V.
- UV-resistant for outdoor use. SMA Solar Technology AG recommends the cable "UC900 SS23 Cat.7 PE"
- Comply with the requirements of the battery manufacturer.

1.3.2 SBS2.5-1VL-10 mit RESU 7H / RESU 10H

SUNNY BOY STORAGE

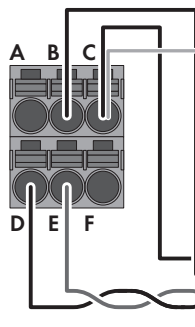

LG Energy Solution RESU 7H / LG Energy Solution RESU 10H

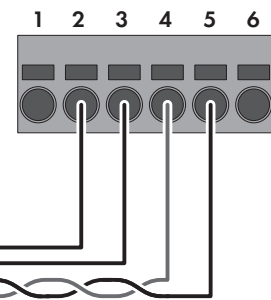

Figure 1: Cabling plan SBS2.5-1VL-10 with RESU 7H / RESU 10H

Clamping position	Assignment	Pin
A	Not used	-
B	Enable 11 V+	3
C	GND and shielding	2
D	CAN L (twisted pair conductors, at least CAT5e)	5
E	CAN H (twisted pair conductors, at least CAT5e)	4
F	Not used	-

1.3.3 SBS2.5-1VL-10 with Battery-Box H

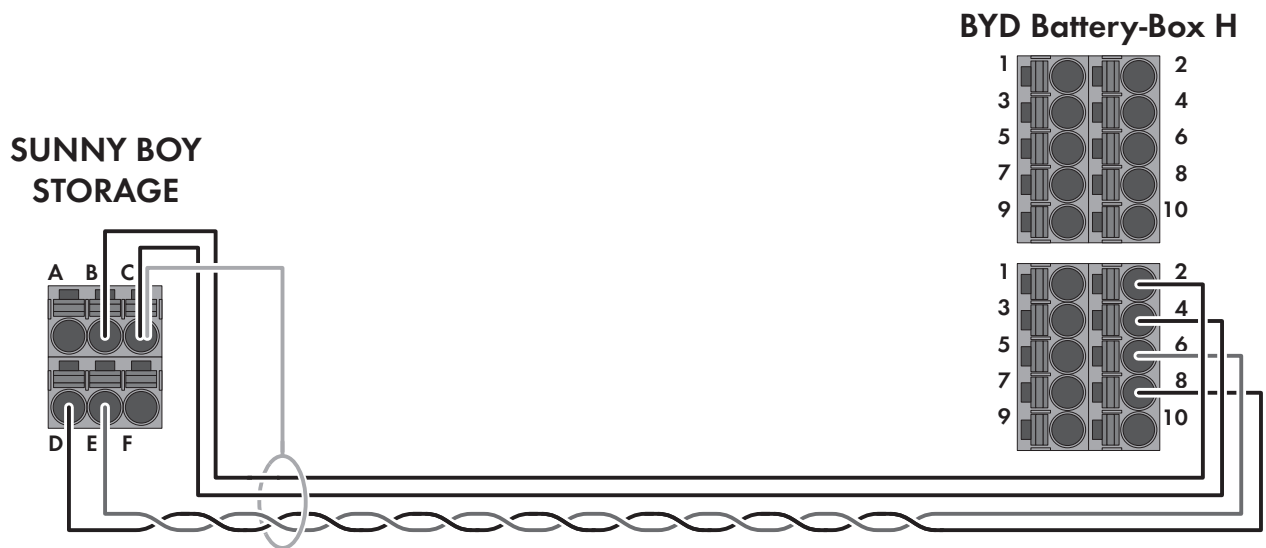
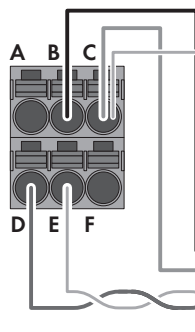

Figure 2: Cabling plan SBS2.5-1VL-10 with Battery-Box H

Clamping position	Assignment	Pin
A	Not used	-
B	Enable 11 V+	2
C	GND and shielding	4
D	CAN L (twisted pair conductors, at least CAT5e)	8
E	CAN H (twisted pair conductors, at least CAT5e)	6
F	Not used	-

1.3.4 SBS2.5-1VL-10 with Battery-Box Premium HVS

SUNNY BOY STORAGE 2.5



BYD Battery-Box Premium HVS

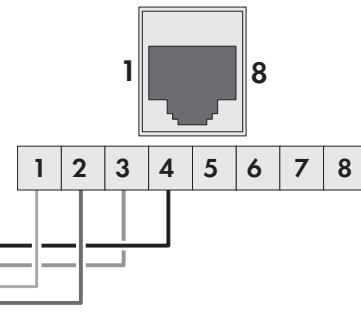

Figure 3: Cabling plan SBS2.5-1VL-10 with Battery-Box Premium HVS

Clamping position	Assignment	Pin
A	Not used	-
B	Enable 11 V+	4
C	GND and shielding	3
D	CAN L (twisted pair conductors, at least CAT5e)	2
E	CAN H (twisted pair conductors, at least CAT5e)	1
F	Not used	-

2 SBS3.7-10 / SBS5.0-10 / SBS6.0-10

2.1 Approved batteries for SBS3.7-10 / SBS5.0-10 / SBS6.0-10

i Firmware version of the battery

The firmware version of the battery can be accessed via the user interface of the inverter. The firmware version of the BYD batteries can also be accessed via the user interface of the battery (see manufacturer's manual). With the exception of the BYD Battery-Box (H, Premium HVS and HVM), LG RESU (10H Prime, 16H Prime and Flex) and Pylontech (Force-H1-V2 and Force-H2-V2), the battery firmware is automatically updated via the inverter.

i Inverter firmware version

The firmware version of the inverter can be accessed via the user interface of the inverter.

Battery type (manufacturer)	Modules	Firmware version of the battery:	Firmware version of the inverter:
AXIstorage Li SH 7.5-15 ²⁾ Item no.: 42257 and 611274, both with Helios 1.5 module (item no.: 37832-02) (AXITEC)	3-6	≥ 0.03.07.R	≥ 3.11.10.R
AXIstorage Li SH 7.5-15 ²⁾ Item no.: 616344 and 616039, both with Helios VE module (Item no.: 612033) (AXITEC)	3-6	≥ 0.03.15.R	≥ 3.12.61.R
Hyperion 7.5-15 ²⁾ Item no.: 41871 with He- lios 1.5 module (item no. 37832-02) (BMZ GmbH)	3-6	≥ 0.03.07.R	≥ 3.11.10.R
Hyperion 7.5-15 (SE) ²⁾ Item no.: 615424 and 616038, both with Helios VE module (Item no.: 612033) (BMZ GmbH)	3-6	≥ 0.03.15.R	≥ 3.12.61.R
era:powerbase 7.5-15 ²⁾ Item no.: 42256 and 611273, both with Helios 1.5 module (item no.: 37832-02) (IBC SOLAR AG)	3-6	≥ 0.03.07.R	≥ 3.11.10.R

²⁾ The battery type is only compatible with the mentioned item number (item no.).

Battery type (manufacturer)	Modules	Firmware version of the battery:	Firmware version of the inverter:
era:powerbase 7.5-15 ²⁾ Item no.: 615423 and 609811, both with Helios VE module (Item no.: 612033) (IBC SOLAR AG)	3-6	≥ 0.03.15.R	≥ 3.12.61.R
Battery-Box H 5.1-10.2 (BYD Company Limited)	4-8	3.00.04.R to 3.00.15.R	≥ 1.00.20.R
Battery-Box Premium HVS 5.1-10.2 ³⁾ (BYD Company Limited)	2-4	BMU ≥ 3.13 BMS ≥ 3.19	≥ 3.11.10.R
Battery-Box Premium HVM 8.3-22.1 (BYD Company Limited)	3-8	BMU ≥ 3.13 BMS ≥ 3.19	≥ 3.11.03.R
RESU 7H / EH111063P3S3 Type C (LG Energy Solution)	Not modular	≥ 16.02.6 R	≥ 1.00.20.R
RESU 10H / 15563P3S- DLT Type C (LG Energy Solution)	Not modular	≥ 16.13.6 R	≥ 1.00.20.R
RESU 10M (LG Energy Solution)	Not modular	≥ 1.01.1 R (only approved for SBS3.7-10)	≥ 3.11.03.R
RESU 10H Prime (LG Energy Solution)	Not modular	≥ 23.12.0 R	≥ 3.12.23.R
RESU 16H Prime (LG Energy Solution)	Not modular	≥ 23.12.0 R	≥ 3.12.23.R
RESU Flex (8.6-17.2) (LG Energy Solution)	2-4	≥ 1.0.0.R	≥ 3.14.10.R

³⁾ When using the BYD Battery-Box Premium HVS with the Sunny Boy Storage 2.5, you must select the Sunny Boy Storage 2.5 inverter during configuration. Observe the information on the current Sunny Boy Storage 2.5 firmware package in the readme file in the download area at www.SMA-Solar.com.

Battery type (manufacturer)	Modules	Firmware version of the battery:	Firmware version of the inverter:
Force-H1-V2 (10.65-24.86) (Pylon Technologies Company Limited)	3-7	≥ 1.2.0.R	≥ 04.04.03.R
Force-H2-V2 (7.10-14.20) (Pylon Technologies Company Limited)	2-4	≥ 1.2.0.R	≥ 04.04.03.R

Synchronizing the battery and battery inverter

All batteries mentioned supply a defined nominal current. Please pay attention to the battery manufacturer's recommendation regarding the suitable dimensioning of the battery in order to achieve the nominal and overload currents of the systems stated in the datasheet with a Sunny Boy Storage. Only if the dimensioning of the battery size is synchronized (battery capacity, battery currents, number of battery modules if necessary), the full functionality and power incl. overload can be guaranteed for the PV storage system with the respective battery inverter in use.

2.2 Overview of the recommended module configurations for SBS3.7-10 / SBS5.0-10 / SBS6.0-10

Type	Module configuration		SBS3.7-10	SBS5.0-10	SBS6.0-10
	Capacity (kWh)	Modules			
Hyperion era:powerbase AXIstorage Li SH	7.5	3	✓	(✓)	(✓)
	10	4	✓	✓	✓
	12.5	5	✓	✓	✓
	15	6	✓	✓	✓
Battery-Box H	5.1	4	✓	(✓)	(✓)
	6.4	5	✓	✓	(✓)
	7.7	6	✓	✓	✓
	9.0	7	✓	✓	✓
	10.2	8	✓	✓	✓
Battery-Box Premium HVS	5.1	2	✓	(✓)	(✓)
	7.7	3	✓	✓	✓
	10.2	4	✓	✓	✓

Type	Module configuration		SBS3.7-10	SBS5.0-10	SBS6.0-10
	Capacity (kWh)	Modules			
Battery-Box Premium HVM	8.3	3	✓	(✓)	(✓)
	11.0	4	✓	✓	(✓)
	13.8	5	✓	✓	✓
	16.6	6	✓	✓	✓
	19.3	7	✓	✓	✓
	22.1	8	✓	✓	✓
RESU 7H type C	Not modular		✓	✓	✓
RESU 10H type C	Not modular		✓	✓	✓
RESU 10M	Not modular		✓	✗	✗
RESU 10H Prime	Not modular		✓	✓	✓
RESU 16H Prime	Not modular		✓	✓	✓
RESU Flex	8.6	2	✓	✓	(✓)
	12.9	3	(✓)	✓	✓
	17.2	4	(✓)	(✓)	✓
Force-H1-V2	10.65	3	✓	(✓)	(✓)
	14.2	4	(✓)	(✓)	✓
	17.76	5	(✓)	(✓)	✓
	21.31	6	(✓)	(✓)	✓
	24.86	7	(✓)	(✓)	✓
Force-H2-V2	7.10	2	(✓)	(✓)	(✓)
	10.65	3	✓	(✓)	(✓)
	14.20	4	(✓)	(✓)	✓

✓ = Yes, (✓) = Limited approval, ✗ = No

background information on the limited approval (example)

In the worst-case scenario, the BYD Battery-Box Premium HVM 8.3 can only provide a maximum output power of 3700 W, depending on the SOC. For this application, the SBS3.7-10 is completely sufficient. Operation with the SBS5.0-10 or SBS6.0-10 is technically possible, but does not make economic sense due to oversizing.

2.3 Overview of the recommended systems for SBS3.7-10 / SBS5.0-10 / SBS6.0-10

Battery type (Module configuration)	Use in systems for/with			Multi-battery operation with batteries	
	Optimization of self-consumption	Secure power supply operation	Battery-backup operation	of the same type	of the different type
AXIstorage Li SH (7.5-15) ⁴⁾ Item no.: 616344 and 616039	✓	✓	✓	✓ ⁵⁾	✗
era:powerbase (7.5-15) ⁴⁾ Item no.: 615423 and 609811	✓	✓	✓	✓ ⁵⁾	✗
Hyperion (7.5-15) ⁴⁾ Item no.: 41871, 615424 and 616038	✓	✓	✓	✓ ⁵⁾	✗
Battery-Box H (5.1-10.2)	✓	✓	✓	✓	✓ RESU 7H und 10H, RESU 10M, RESU Flex, HVS, HVM, Force-H1- V2, Force-H2-V2
Battery-Box Pre- mium HVS (5.1-10.2)	✓	✓	✓	✓	✓ RESU 10M, RESU Flex, HVM, Battery-Box H, Force-H1-V2, Force-H2-V2
Battery-Box Pre- mium HVM (8.3-22.1)	✓	✓	✓	✓	✓ RESU 10M, RESU Flex, HVS, Battery-Box H, Force-H1-V2, Force-H2-V2

⁴⁾ The battery type is only compatible with the mentioned item number (item no.).

⁵⁾ From battery firmware 0.04.20.R

Battery type (Module configuration)	Use in systems for/with			Multi-battery operation with batteries	
	Optimization of self-consumption	Secure power supply operation	Battery-backup operation	of the same type	of the different type
RESU 7H Type C	✓	✓	✗ (✓ ⁶⁾)	✓	✓ RESU 10H, Battery-Box H
RESU 10H Type C	✓	✓	✗ (✓ ⁶⁾)	✓	✓ RESU 7H, Battery-Box H
RESU 10M	✓	✓	✓	✓	✓ RESU Flex, Battery-Box H, HVS, HVM
RESU 10H Prime	✓	✓	✓	✓	✓ RESU 16H Prime, RESU Flex
RESU 16H Prime	✓	✓	✓	✓	✓ RESU 10H Prime, RESU Flex
RESU Flex (8.6-17.2)	✓	✓	✓	✓	✓ RESU 10H/16H Prime, Battery-Box H, HVS, HVM, Force-H1-V2, Force-H2-V2
Force-H1-V2 (10.65-24.86)	✓	✓	✓	✓	✓ Force-H2-V2, Battery-Box H, HVS, HVM, RESU Flex
Force-H2-V2 (7.10-14.20)	✓	✓	✓	✓	✓ Force-H1-V2, Battery-Box H, HVS, HVM, RESU Flex

⁶⁾ Depending on the state of charge in terms of battery and PV generation, it can happen that the battery-backup grid is interrupted for a few seconds in battery-backup operation mode during load changes and then restarts again. To prevent this behavior, SMA Solar Technology AG recommends to set the parameters **Output power limitation of PV inverter**, **Permanently derated** and **Upper limit for the charging state for derating of the PV inverters** to 0. If this setting is enabled, the battery can no longer be charged by the PV system during battery-backup operation.

✓ = Yes, ✗ = No

i **Battery-backup operation with RESU 10H/16H Prime**

The RESU 10H/16H Prime can be used in battery-backup systems. Due to the integrated DC-to-DC controller in the battery, restrictions can occur with very large load jumps depending on the state of charge. In this case, the system restarts automatically after a short interruption of the battery-backup grid of 1 to 2 seconds.

2.4 Battery Communication Connection

2.4.1 Battery data cable requirements for SBS3.7-10 / SBS5.0-10 / SBS6.0-10

- Twisted pair conductors
- Cable category: minimum CAT5e
- Cable with shielding: Yes
- Conductor cross-section: 0.25 mm² to 0.34 mm² (24 AWG to 16 AWG)
- External diameter: 6 mm to 8.5 mm (0.24 in to 0.33 in)
- Recommended number of conductor pairs: 4
- Maximum cable length between battery and inverter and, in battery-backup systems, between automatic transfer switch and inverter: 10 m (33 ft)
- The cable has to be insulated for 600 V.
- UV-resistant for outdoor use.
- Comply with the requirements of the battery manufacturer.

2.4.2 SBS3.7-10 / SBS5.0-10 / SBS6.0-10 with RESU 7H / 10H

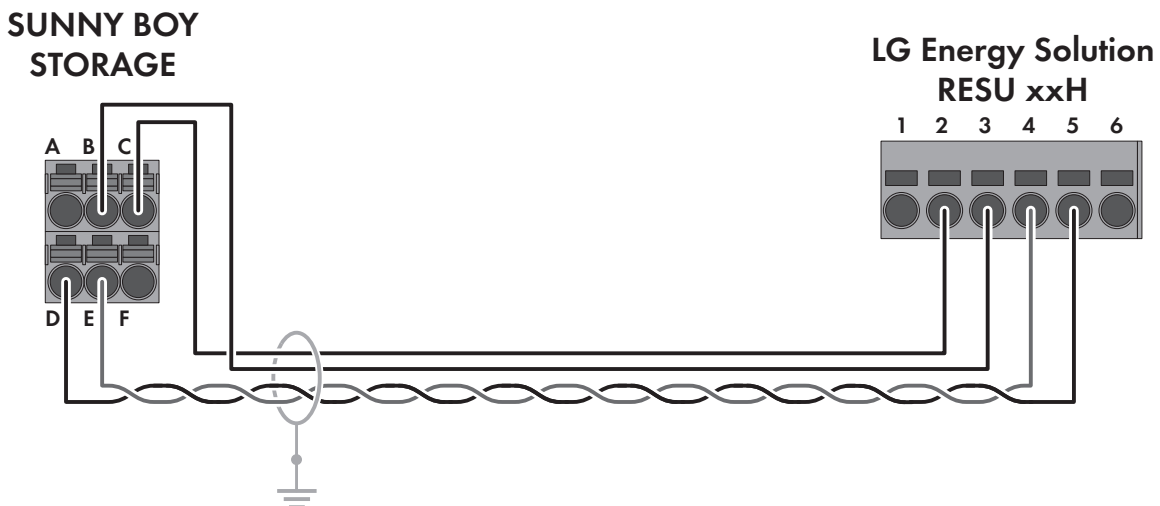

Figure 4: SBS3.7-10 / SBS5.0-10 / SBS6.0-10 with RESU 7H / RESU 10H

Clamping position	Assignment	Pin
A	Not used	-
B	Enable 11 V+	3
C	GND	2
D	CAN L (twisted pair conductors, at least CAT5e)	5
E	CAN H (twisted pair conductors, at least CAT5e)	4
F	+ 12 V supply for automatic transfer switching device	-

2.4.3 SBS3.7-10 / SBS5.0-10 / SBS6.0-10 with RESU 10H Prime / 16H Prime

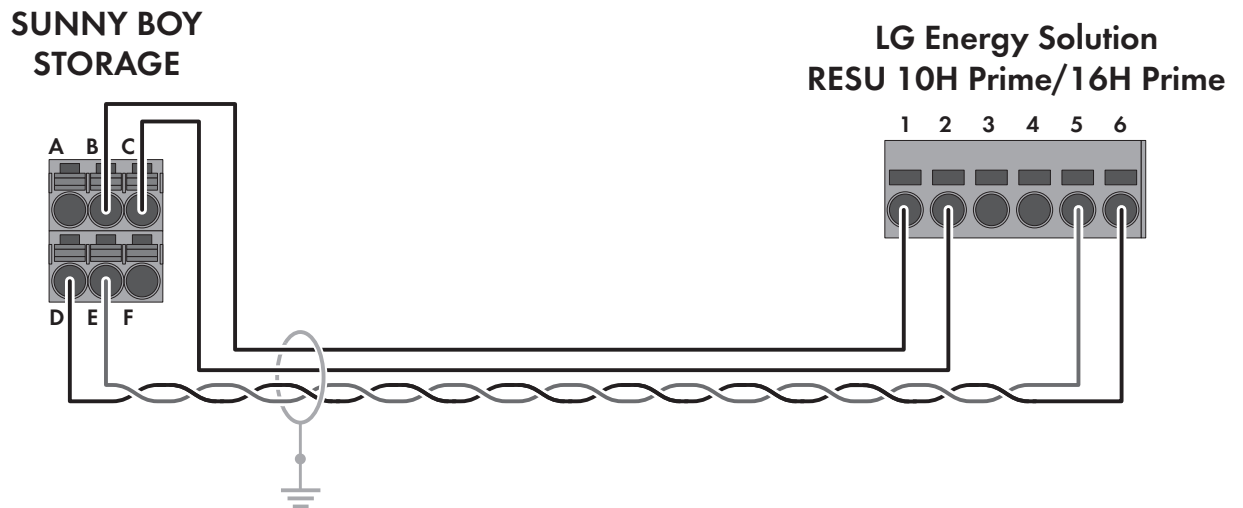

Figure 5: Cabling plan SBS3.7-10 / SBS5.0-10 / SBS6.0-10 with RESU 10H Prime / 16H Prime

Clamping position	Assignment	Pin
A	Not used	-
B	Enable 11 V+	1
C	GND	2
D	CAN L (twisted pair conductors, at least CAT5e)	6
E	CAN H (twisted pair conductors, at least CAT5e)	5
F	+12V supply for automatic transfer switching device	-

2.4.4 SBS3.7-10 / SBS5.0-10 / SBS6.0-10 with RESU Flex

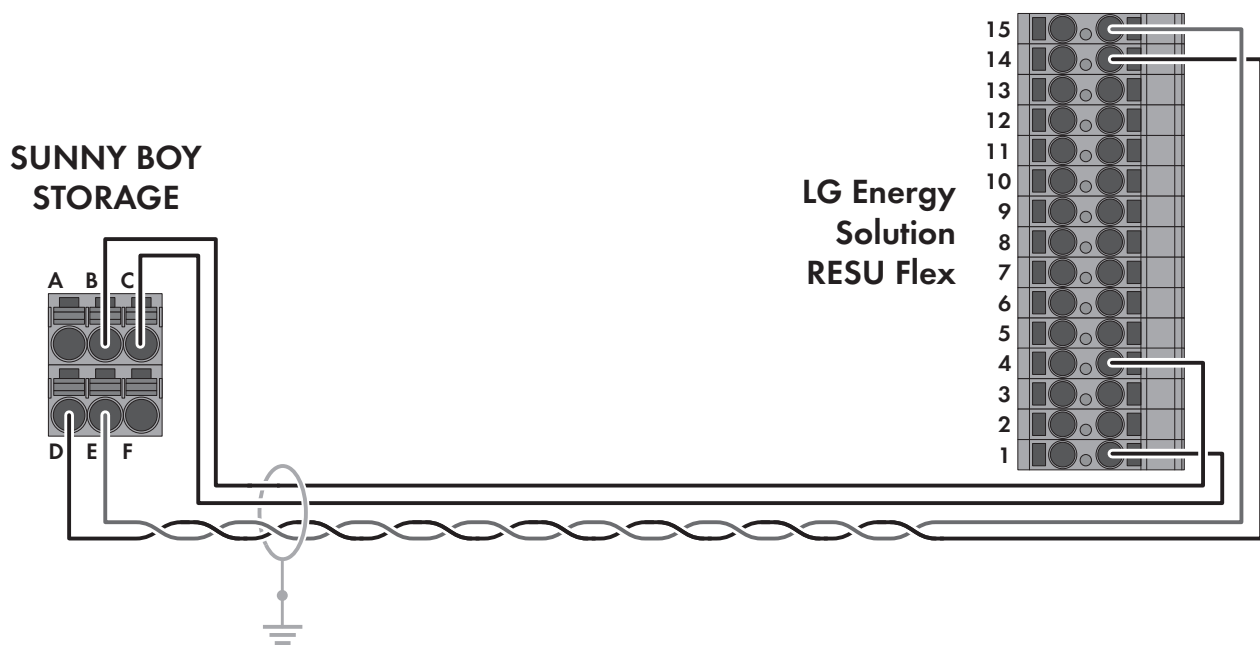

Figure 6: Cabling plan SBS3.7-10 / SBS5.0-10 / SBS6.0-10 with RESU Flex

Clamping position	Assignment	Pin
A	Not used	-
B	Enable 11 V+	4
C	GND	1
D	CAN L (twisted pair conductors, at least CAT5e)	14
E	CAN H (twisted pair conductors, at least CAT5e)	15
F	+12V supply for automatic transfer switching device	-

2.4.5 SBS3.7-10 / SBS5.0-10 / SBS6.0-10 with Battery-Box H

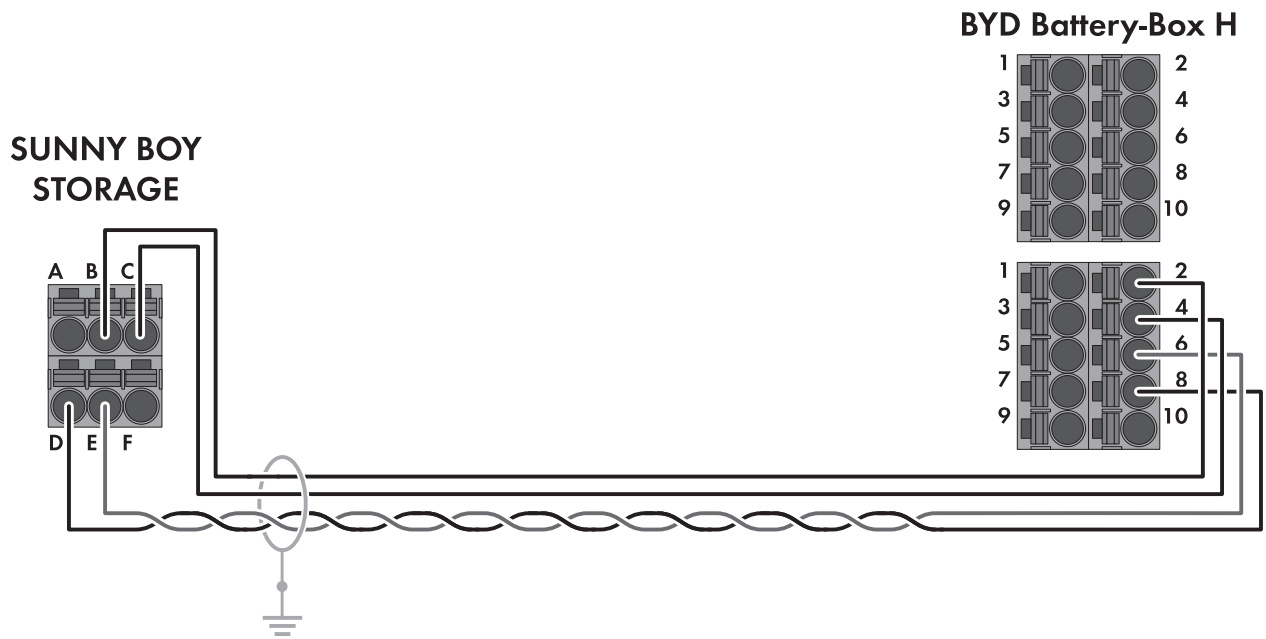

Figure 7: Cabling plan SBS3.7-10 / SBS5.0-10 / SBS6.0-10 with Battery-Box H

Clamping position	Assignment	Pin
A	Not used	-
B	Enable 11 V+	2
C	GND	4
D	CAN L (twisted pair conductors, at least CAT5e)	8
E	CAN H (twisted pair conductors, at least CAT5e)	6
F	+12V supply for automatic transfer switching device	-

2.4.6 SBS3.7-10 / SBS5.0-10 / SBS6.0-10 with Battery-Box Premium HVS and HVM

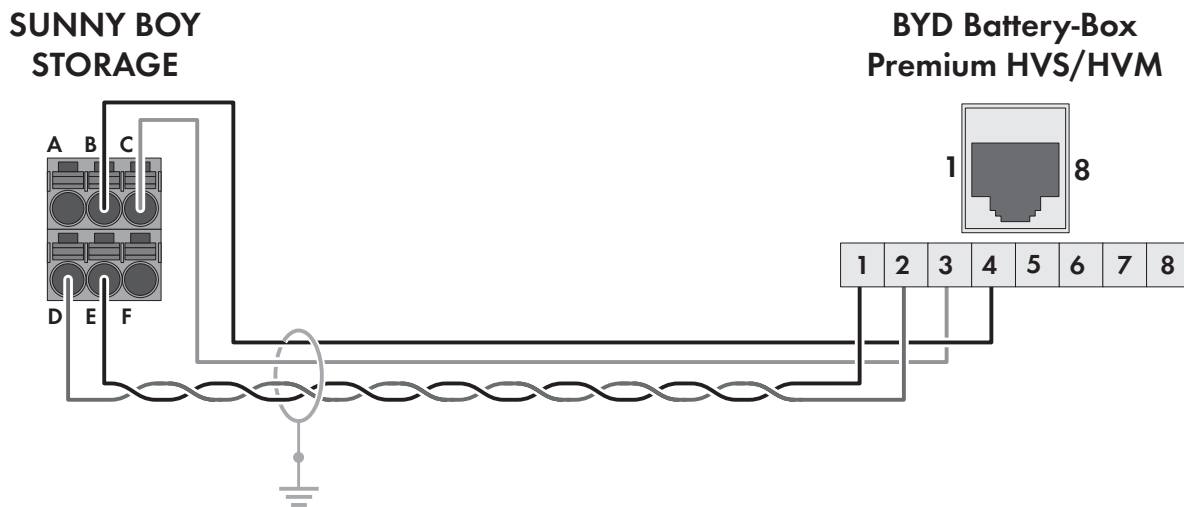

Figure 8: Cabling plan SBS3.7-10 / SBS5.0-10 / SBS6.0-10 with Battery-Box Premium HVS and HVM

Clamping position	Assignment	Pin
A	Not used	-
B	Enable 11 V+	4
C	GND	3
D	CAN L (twisted pair conductors, at least CAT5e)	2
E	CAN H (twisted pair conductors, at least CAT5e)	1
F	+12V supply for automatic transfer switching device	-

2.4.7 SBS3.7-10 / SBS5.0-10 / SBS6.0-10 with BMZ Hyperion, IBC era:powerbase and Axitec AXIstorage Li SH

SUNNY BOY STORAGE

BMZ Hyperion / IBC era:powerbase / Axitec AXIstorage LI SH

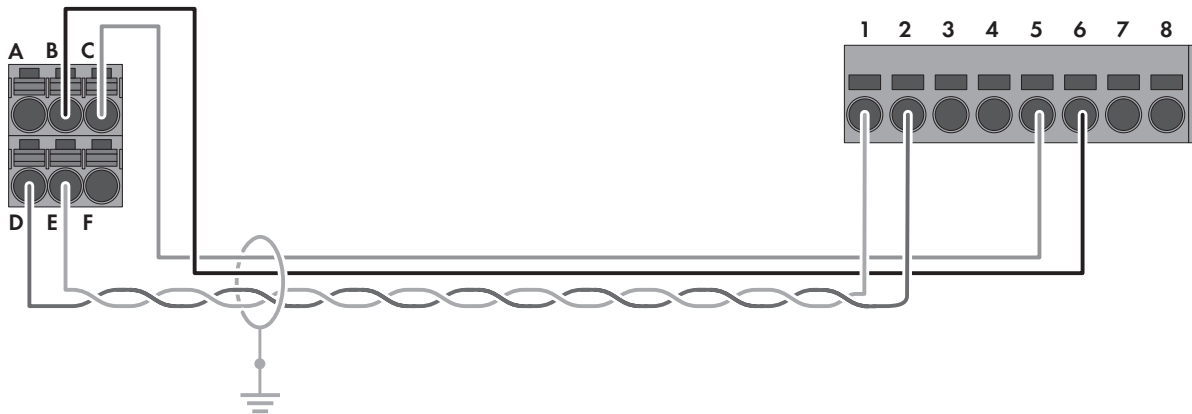

Figure 9: Cabling plan SBS3.7-10 / SBS5.0-10 / SBS6.0-10 with BMZ Hyperion, IBC era:powerbase and Axitec AXIstorage Li SH

Clamping position	Assignment	Clamping position
A	Not used	-
B	Enable 11 V+	6 (orange)
C	GND	5 (blue)
D	CAN L (twisted pair conductors, at least CAT5e)	2 (white)
E	CAN H (twisted pair conductors, at least CAT5e)	1 (yellow)
F	+12V supply for automatic transfer switching device	-

2.4.8 SBS3.7-10 / SBS5.0-10 / SBS6.0-10 with Pylontech Force-H1-V2

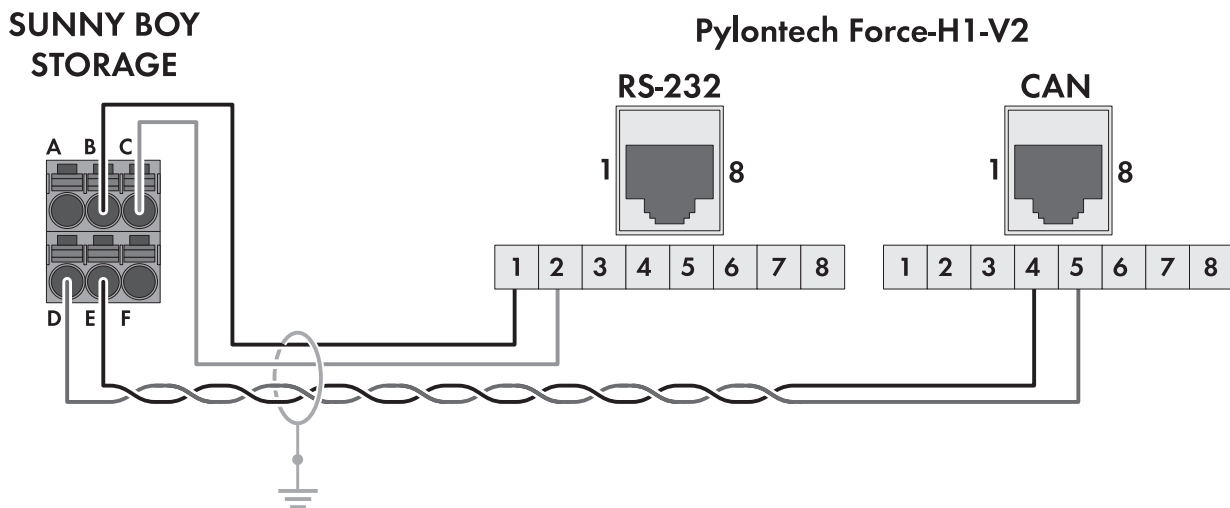

Figure 10: Cabling plan SBS3.7-10 / SBS5.0-10 / SBS6.0-10 with Pylontech Force-H1-V2

Clamping position	Assignment	Clamping position
A	Not used	-
B	Enable 11 V+	1 (RS-232)
C	GND	2 (RS-232)
D	CAN L (twisted pair conductors, at least CAT5e)	5 (CAN)
E	CAN H (twisted pair conductors, at least CAT5e)	4 (CAN)
F	+12V supply for automatic transfer switching device	-

2.4.9 SBS3.7-10 / SBS5.0-10 / SBS6.0-10 with Pylontech Force-H2-V2

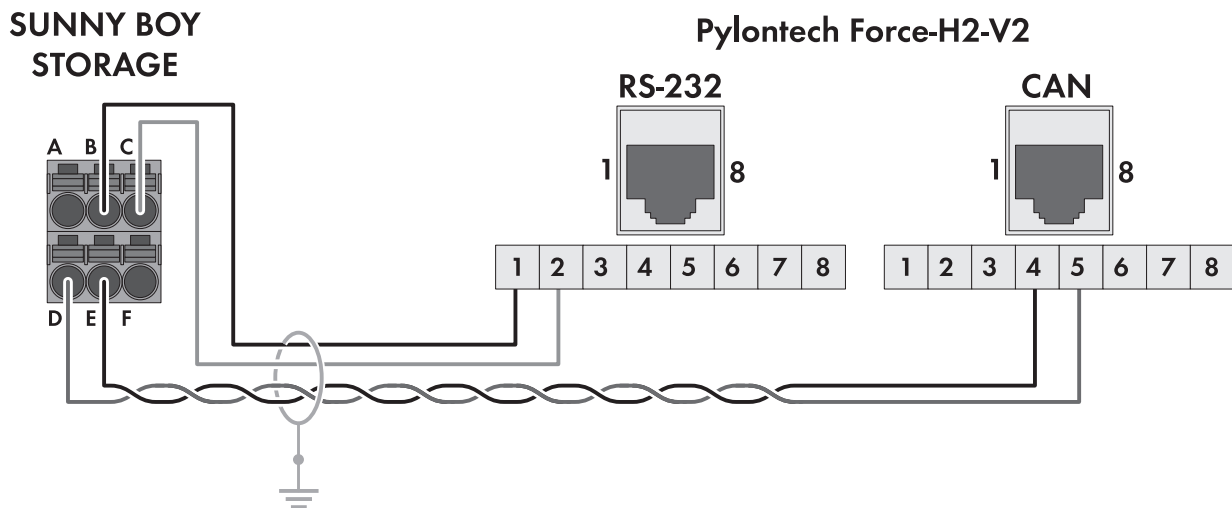

Figure 11: Cabling plan SBS3.7-10 / SBS5.0-10 / SBS6.0-10 with Pylontech Force-H2-V2

Clamping position	Assignment	Clamping position
A	Not used	-
B	Enable 11 V+	1 (RS-232)
C	GND	2 (RS-232)
D	CAN L (twisted pair conductors, at least CAT5e)	5 (CAN)
E	CAN H (twisted pair conductors, at least CAT5e)	4 (CAN)
F	+12V supply for automatic transfer switching device	-

2.4.10 SBS3.7-10 with RESU 10M

SUNNY BOY
STORAGE 3.7

LG Energy Solution RESU 10M

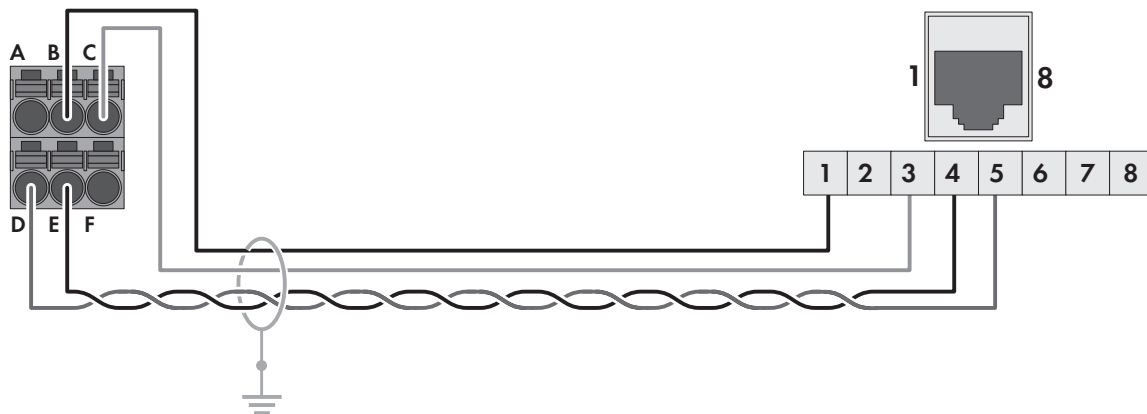

Figure 12: Cabling plan SBS3.7-10 with RESU 10M

Clamping position	Assignment	Pin
A	Not used	-
B	Enable 11 V+	1
C	GND	3
D	CAN L (twisted pair conductors, at least CAT5e)	5
E	CAN H (twisted pair conductors, at least CAT5e)	4
F	+12V supply for automatic transfer switching device	-

2.5 Connection of the battery power cable to the SBS3.7-10 / SBS5.0-10 / SBS6.0-10

2.5.1 SBS3.7-10 / SBS5.0-10 / SBS6.0-10 and LG RESU 7H / 10H

To connect the battery power cables from an LG RESU 7H or LG RESU 10H, proceed according to the connection option "Connection of batteries with a charging/discharging current limit of 20 A ". For further information on the connection options, refer to the inverter manual at www.SMA-Solcar.com.

The DC terminals **A** and **B** must be connected in parallel using the jumpers provided.

The battery must be connected to the terminal blocks **A+** and **A-**.

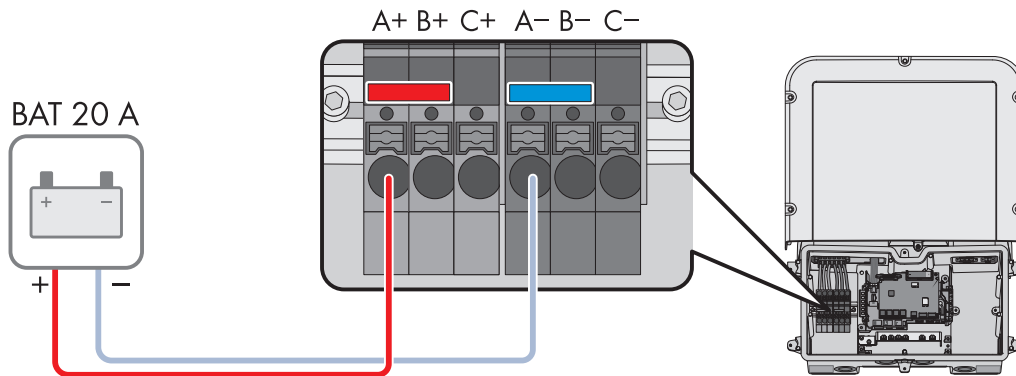

Figure 13: Overview for connection of a battery with a charging/discharging current limit of 20 A

2.5.2 SBS3.7-10 / SBS5.0-10 / SBS6.0-10 and batteries with a charging/ discharging current greater than 20 A

To connect the battery power cable from the following batteries, proceed according to the connection option "Connection of batteries with a charging/discharging current limit of 20 A". For further information on the connection options, refer to the inverter manual at www.SMA-Solcar.com.

- LG RESU 10M
- LG RESU 10H Prime
- LG RESU 16H Prime
- LG RESU Flex 8.6-17.2
- BYD Battery-Box H 5.1-10.2
- BYD Battery-Box Premium HVS 5.1-10.2
- BYD Battery-Box Premium HVM 8.3-22.1
- BYD Battery-Box Premium HVL 12.0-32.0
- BMZ Hyperion 7.5-15
- IBC SOLAR era:powerbase 7.5-15
- Axitec AXIstorage Li SH 7.5-15
- Pylontech Force-H1-V2 (10.65-24.86)
- Pylontech Force-H2-V2 (7.10-14.20)

All DC terminals must be switched parallelly with the jumpers provided.

The battery must be connected to the terminal blocks **A+** and **A-**.

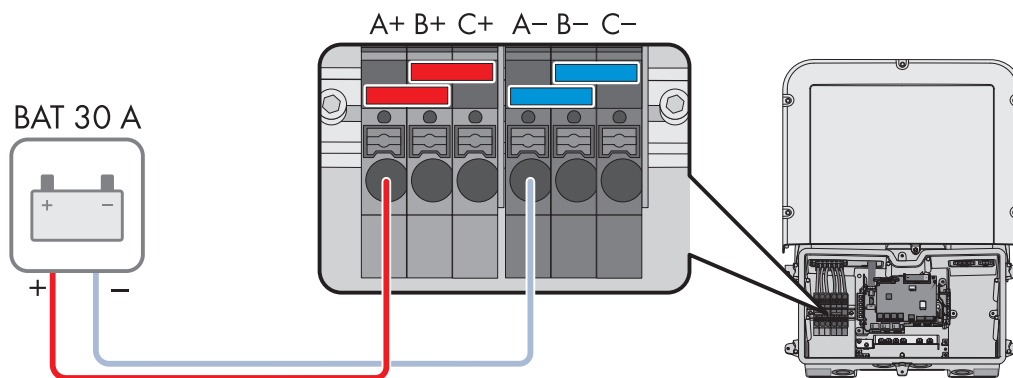

Figure 14: Overview for connection of one battery with a charging/discharging current higher than 20 A.

2.6 Approved automatic transfer switching devices for SBS3.7-10 / SBS5.0-10 / SBS6.0-10

The following automatic transfer switching devices are allowed to be used when operating the Sunny Boy Storage 3.7 / 5.0 / 6.0:

Manufacturer	Article no.	Designation	Compatible PV inverters	Country approval
enwitec electronic GmbH & Co.KG	10012856_V1.5	3PH grid switchover box	2 x Sunny Boy (no support for battery-backup operation with 1PH grid switchover box) 1 x Sunny Tripower (with 3PH grid switchover box)	Germany, Austria, Switzerland
enwitec electronic GmbH & Co.KG	10012945_V1.4	3PH grid switchover box	2 x Sunny Boy	Germany, Austria, Switzerland
enwitec electronic GmbH & Co.KG	10013490_V1.0	1PH grid switchover box	1 x Sunny Boy or max. 2 x Sunny Boy 3.0	Italy
enwitec electronic GmbH & Co.KG	10013491_V1.0	3PH grid switchover box	2 x Sunny Boy 1 x Sunny Tripower	Italy
enwitec electronic GmbH & Co.KG	10013993_V1.1	1PH grid switchover box	Not specified (Connection of PV inverters outside of the automatic transfer switching device. Observe the manufacturer documentation)	France, Belgium, Netherlands, Spain, Portugal
enwitec electronic GmbH & Co.KG	10013994_V1.1	3PH grid switchover box	Not specified (Connection of PV inverters outside of the automatic transfer switching device. Observe the manufacturer documentation)	France, Belgium, Netherlands, Spain, Portugal
SMA Solar Technology AG	SBS-ABU-63.1-AU-10	Automatic Backup Unit	1 x Sunny Boy	Australia

3 SBS3.8-US-10 / SBS5.0-US-10 / SBS6.0-US-10

3.1 Approved batteries for SBS3.8-US-10 / SBS5.0-US-10 / SBS6.0-US-10

i Firmware version of the battery

The firmware version of the battery can be accessed via the user interface of the inverter. The firmware version of the BYD batteries can also be accessed via the user interface of the battery (see manufacturer's manual). With the exception of the BYD Battery-Box (H, Premium HVL) and LG RESU 16H Prime, the battery firmware is automatically updated via the inverter.

i Inverter firmware version

The firmware version of the inverter can be accessed via the user interface of the inverter.

i The batteries are UL 9540 certified.

These batteries are certified for the operation with the Sunny Boy Storage in SMA Energy Storage systems according to UL 9540. The batteries are listed in accordance with UL 9540.

Type (module) (Manufacturer)	Firmware version of the battery:	Firmware version of the inverter:
Battery-Box H (5.0-10.0) (BYD Company Limited)	≥ 3.00.04R	≥ 1.00.20.R
Battery-Box Premium HVL (12.0-32.0) (BYD Company Limited)	≥ BMU 3.15.R ≥ BMS 3.22.R	≥ 3.12.23.R
RESU 10H / R15563P3SDLT (LG Energy Solution)	≥ 16.13.6 R ⁷⁾	≥ 1.00.20.R
RESU 16H Prime (LG Energy Solution)	≥ 23.12.0.R	≥ 3.12.23.R

Synchronizing the battery and battery inverter

All batteries mentioned supply a defined nominal current. Please pay attention to the battery manufacturer's recommendation regarding the suitable dimensioning of the battery in order to achieve the nominal and overload currents of the systems stated in the datasheet with a Sunny Boy Storage. Only if the dimensioning of the battery size is synchronized (battery capacity, battery currents, number of battery modules if necessary), the full functionality and power incl. overload can be guaranteed for the PV storage system with the respective battery inverter in use.

⁷⁾ The firmware version of the battery can be updated via the user interface of the inverter.

3.2 Overview of the recommended systems for SBS3.8-US-10 / SBS5.0-US-10 / SBS6.0-US-10

i Battery-backup operation with RESU 16H Prime

The RESU 16H Prime can be used in battery-backup systems. Due to the integrated DC-to-DC controller in the battery, depending on the state of charge and the PV inverter used, restrictions may occur with very large load jumps (approx. 3 kW when used with the Sunny Boy-US). In this case, the system restarts automatically after a short interruption of the battery-backup grid of 1 to 2 seconds.

Type (module configuration)	Use in systems for/with			Multi-battery operation with batteries	
	Optimization of self-consumption	Secure power supply operation	Battery-backup operation	of the same type	of the different type
Battery-Box H (5.1-10.2) (BYD Company Limited)	✓	✓	✓	✓	✓ RESU 10H, HVL
Battery-Box Premium HVL (12.0-32.0) ⁸⁾ (BYD Company Limited)	✓	✓	✓	✓	✓ Battery-Box H
RESU 10H type C (LG Energy Solution)	✓	✓	✓ ⁹⁾	✓	✓ Battery-Box H
RESU 16H Prime (LG Energy Solution)	✓	✓	✓	✓	✗

✓ = Yes, ✗ = No

⁸⁾ The Battery-Box Premium HVL 12.0 is recommended only with the SBS3.8-US-10 or SBS5.0-US-10 due to limited charging and discharging power. When used with the SBS6.0-US-10, the inverter's nominal power of 6 kW is not reached.

⁹⁾ The use in battery-backup systems is only possible to a limited extent (see "Technical Statement - LG Energy Solution RESU10H when used in AC-Coupled Battery Backup Systems" at <http://www.SMA-Solar.com>).

3.3 Battery Communication Connection

3.3.1 Battery data cable requirements for SBS3.8-US-10 / SBS5.0-US-10 / SBS6.0-US-10

- Twisted pair conductors
- Cable category: minimum CAT5e
- Cable with shielding: Yes
- Conductor cross-section: 0.25 mm² to 0.34 mm² (24 AWG to 16 AWG)
- External diameter: 6 mm to 8.5 mm (0.24 in to 0.33 in)
- Recommended number of conductor pairs: 4
- Maximum cable length between battery and inverter and, in battery-backup systems, between automatic transfer switch and inverter: 10 m (33 ft)
- If the cables are routed together with the DC conductors in a conduit, each cable has to be insulated for 600 V.
- UV-resistant for outdoor use.
- Comply with the requirements of the battery manufacturer.

3.3.2 SBS3.8-US-10 / SBS5.0-US-10 / SBS6.0-US-10 with RESU 7H / 10H

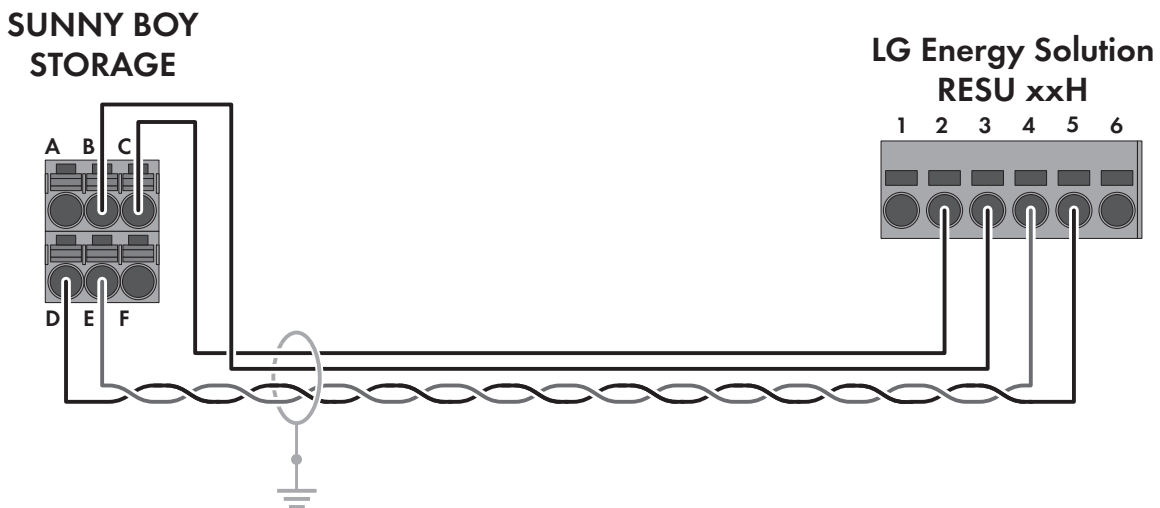

Figure 15: Cabling plan SBS3.8-US-10 / SBS5.0-US-10 / SBS6.0-US-10 with RESU 7H / RESU 10H

Clamping position	Assignment	Pin
A	Not used	-
B	Enable 11 V+	3
C	GND	2
D	CAN L (twisted pair conductors, at least CAT5e)	5
E	CAN H (twisted pair conductors, at least CAT5e)	4
F	+12V supply for automatic transfer switching device	-

3.3.3 SBS3.8-US-10 / SBS5.0-US-10 / SBS6.0-US-10 with RESU 16H Prime

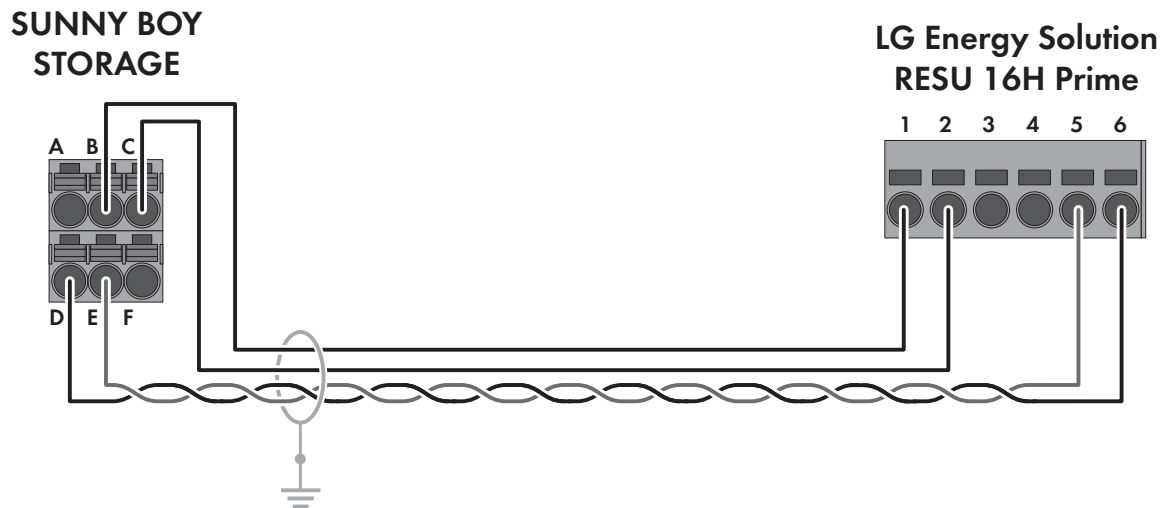

Figure 16: Cabling plan SBS3.8-US-10 / SBS5.0-US-10 / SBS6.0-US-10 with RESU 16H Prime

Clamping position	Assignment	Pin
A	Not used	-
B	Enable 11 V+	1
C	GND	2
D	CAN L (twisted pair conductors, at least CAT5e)	6
E	CAN H (twisted pair conductors, at least CAT5e)	5
F	+12V supply for automatic transfer switching device	-

3.3.4 SBS3.8-US-10 / SBS5.0-US-10 / SBS6.0-US-10 with Battery-Box H

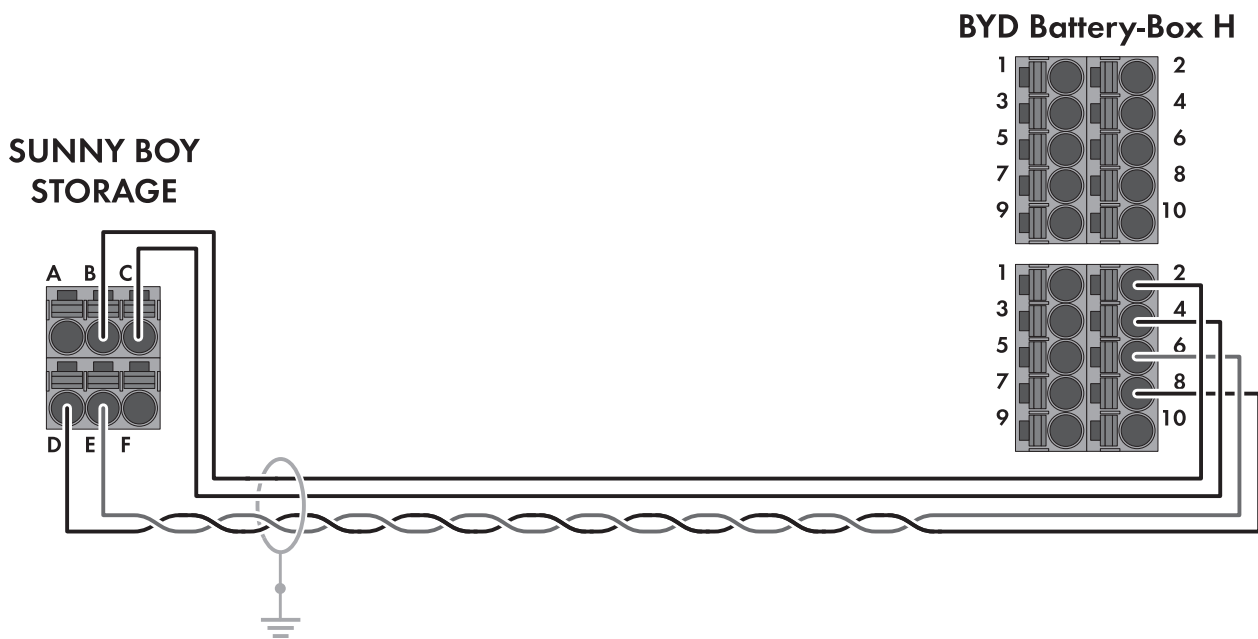
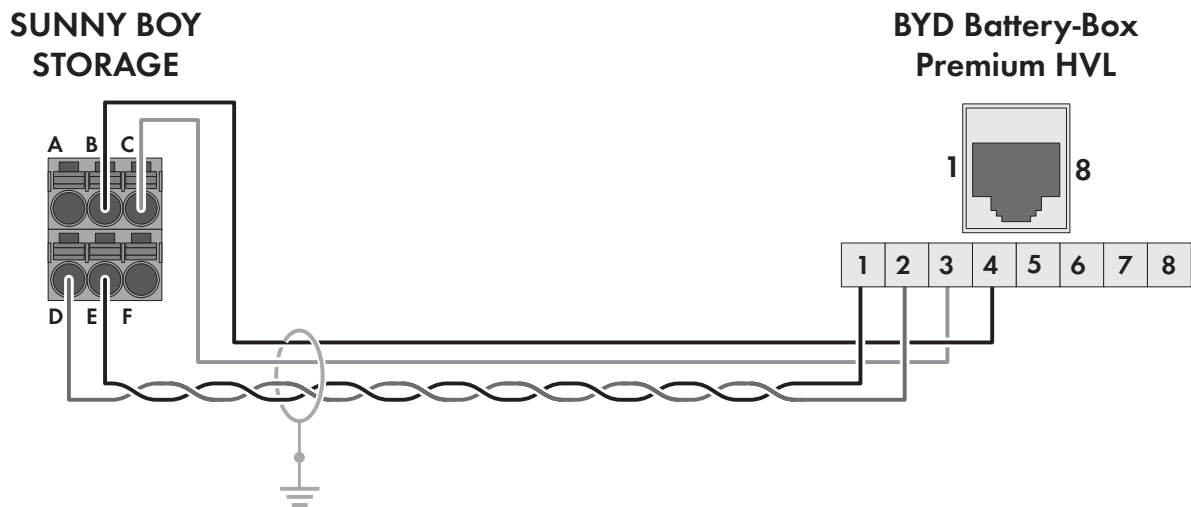

Figure 17: Cabling plan SBS3.8-US-10 / SBS5.0-US-10 / SBS6.0-US-10 with BYD Battery-Box H

Clamping position	Assignment	Pin
A	Not used	-
B	Enable 11 V+	2
C	GND	4
D	CAN L (twisted pair conductors, at least CAT5e)	8
E	CAN H (twisted pair conductors, at least CAT5e)	6
F	+12V supply for automatic transfer switching device	-

3.3.5 SBS3.8-US-10 / SBS5.0-US-10 / SBS6.0-US-10 with Battery-Box Premium HVL



Clamping position	Assignment	Pin
A	Not used	-
B	Enable 11 V+	4
C	GND	3
D	CAN L (twisted pair conductors, at least CAT5e)	2
E	CAN H (twisted pair conductors, at least CAT5e)	1
F	+12V supply for automatic transfer switching device	-

3.4 Approved automatic transfer switching devices for SBS3.8-US-10 / SBS5.0-US-10 / SBS6.0-US-10

The following automatic transfer switching devices are allowed to be used when operating the Sunny Boy Storage 3.8-US / 5.0-US / 6.0-US:

Manufacturer	Article no.	Designation	Compatible PV inverters	Country approval
SMA Solar Technology AG	SBS-ABU-200-US-10 / BUUM3-US-10	Automatic Backup Unit	1 x Sunny Boy	USA and Canada

4 General Information

4.1 Upper battery charge limit

Unlike with lead-acid batteries, a parameterization of the upper battery charging limit does not make sense when using lithium-ion batteries.

There is a battery management system (BMS) in each lithium-ion battery, which dynamically adapts the limiting values depending on the module temperature, the state of charge of the battery (SOC) and also individual cells, thus optimizing the service life of the battery. Thus, the upper battery charging limit is adapted on its own through the BMS.

In addition, it is important to approach the upper battery charging limit at longer intervals in order to prevent the cells connected in series from drifting apart. With this type of calibration, the 100 % SOC value of the battery is relearned and the displayed value is thus synchronized with the actual state of charge of the battery.

For the reasons mentioned, the still partly visible parameter for the upper battery charging limit in the Sunny Boy Storage does not have any function when using lithium-ion batteries.

4.2 DC input current monitoring system

From firmware version 3.11.03.R, the Sunny Boy Storage are equipped with a DC input current monitoring system. If the limit of 40 A is exceeded, the battery is automatically switched off for protection. This results in a permanent operation inhibition. It is therefore not necessary to install an external fuse between battery and Sunny Boy Storage for all listed batteries, even those with output currents greater than 40 A.

ENERGY
THAT
CHANGES



www.SMA-Solar.com

