



# Grid-connected PV Inverter

SUN-3.6K-G05P1-EU-AM2

SUN-4K-G05P1-EU-AM2

SUN-4.2K-G05P1-EU-AM2

SUN-4.6K-G05P1-EU-AM2

SUN-5K-G05P1-EU-AM2

SUN-5.2K-G05P1-EU-AM2

SUN-6K-G05P1-EU-AM2

SUN-6.2K-G05P1-EU-AM2

## User Manual

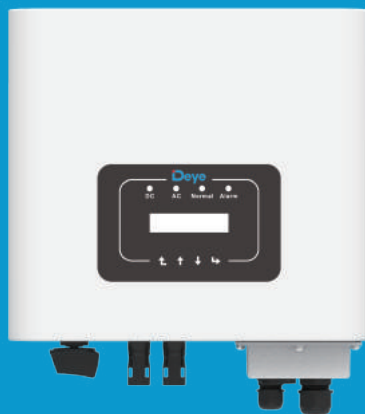

# Contents

<b>1. Introduction</b>	- 1 -
1.1 Appearance Introduction	- 1 -
1.2 Labels description	- 2 -
1.3 Parts list	- 2 -
1.4 Product handling requirements	- 3 -
<b>2. Safety warnings and instructions</b>	- 4 -
2.1 Safety signs	- 4 -
2.2 Safety instructions	- 4 -
2.3 Notes for using	- 5 -
<b>3. Operation Interface</b>	- 6 -
3.1 Interface View	- 6 -
3.2 Status Indicator	- 6 -
3.3 Buttons	- 7 -
3.4 LCD Display	- 7 -
<b>4. Product installation</b>	- 8 -
4.1 Select installation location	- 8 -
4.2 Installations Tools	- 10 -
4.3 Inverter Installation	- 12 -
<b>5. Electrical Connection</b>	- 13 -
5.1 PV Module Selection	- 13 -
5.2 DC input terminal connection	- 13 -
5.3 AC input terminal connection	- 15 -
5.4 The connection of the ground line	- 16 -
5.5 Max. over current protection device	- 17 -
5.6 Inverter monitoring connection	- 17 -
5.7 Installation of datalogger	- 18 -
5.8 Configuration of datalogger	- 18 -
<b>6. Startup and Shutdown</b>	- 18 -
6.1 Start up the inverter	- 19 -
6.2 Inverter Shutdown	- 19 -
6.3 Anti-PID Function(optional)	- 19 -

<b>7. Zero-export function via energy meter</b>	- 20 -
7.1 Use of zero-export function	- 29 -
7.2 Sensor Clamp(optional)	- 29 -
7.3 Use of limiter function	- 31 -
7.4 Notes while using limiter function	- 32 -
7.5 How to browse the load power of your PV grid-tieplant on monitoring platform?	- 32 -
<b>8. General Operation</b>	- 34 -
8.1 The initial interface	- 35 -
8.2 Submenus in the Main Menu	- 36 -
8.3 System param setting	- 38 -
8.4 Running param setting	- 39 -
8.5 Protect Param setting	- 43 -
8.6 Comm. param setting	- 45 -
<b>9. Repair and Maintenance</b>	- 46 -
<b>10. Error information and processing</b>	- 46 -
10.1 Error code	- 46 -
<b>11. Specification</b>	- 50 -
<b>12. EU Declaration of Conformity</b>	- 53 -

## About This Manual

The manual mainly describes the product information, guidelines for installation, operation and maintenance. The manual cannot include complete information about the photovoltaic (PV) system.

## How to Use This Manual

Read the manual and other related documents before performing any operation on the inverter. Documents must be stored carefully and be available at all times. **Contents may be periodically updated or revised due to product development. The information in this manual is subject to change without notice.** The latest manual can be acquired via [service@deye.com.cn](mailto:service@deye.com.cn)

## Photovoltaic Grid-connected System

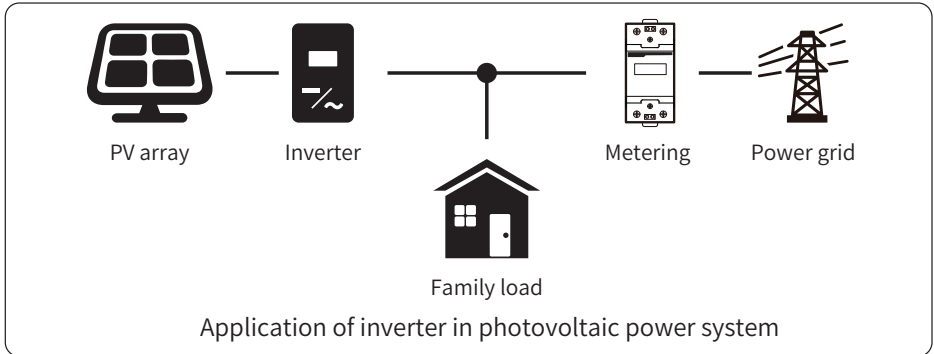

## 1. Introduction



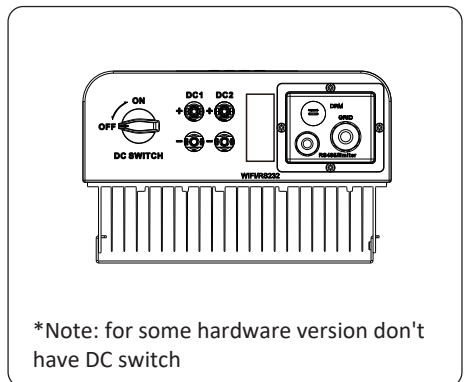
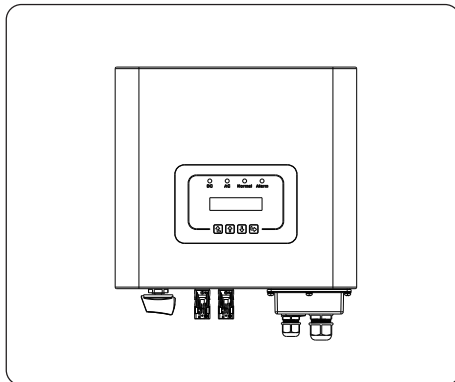

### 1.1 Appearance Introduction

Single Phase String Power Inverter can convert solar panel DC power into AC power which can directly input to the grid. Its appearance is shown below. These models contain SUN-3.6K-G05P1-EU-AM2, SUN-4K-G05P1-EU-AM2, SUN-4.2K-G05P1-EU-AM2, SUN-4.6K-G05P1-EU-AM2, SUN-5K-G05P1-EU-AM2, SUN-5.2K-G05P1-EU-AM2, SUN-6K-G05P1-EU-AM2, SUN-6.2K-G05P1-EU-AM2.

The following is collectively referred to as “inverter” .







## 1.2 Labels description

Label	Description
	Caution, risk of electric shock symbol indicates important safety instructions, which if not correctly followed, could result in electric shock.
	The DC input terminals of the inverter must not be grounded.
	CE mark of conformity
	Please read the instructions carefully before use.
	Symbol for the marking of electrical and electronics devices according to Directive 2002/96/EC. Indicates that the device, accessories and the packaging must not be disposed as unsorted municipal waste and must be collected separately at the end of the usage. Please follow Local Ordinances or Regulations for disposal or contact an authorized representative of the manufacturer for information concerning the decommissioning of equipment.

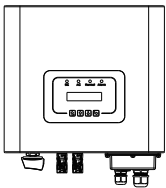
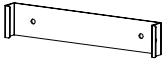
## 1.3 Parts list

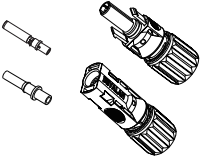
Please check the following table, to see whether all the parts are included in the package:

		
Grid-tied PV String Inverter x1	Wall mounting bracket x1	Stainless steel screws M4×12 x3
		
DC+/DC- Plug connectors including metal terminal xN	Stainless steel anti-collision bolt M6×60 x2	User manual x1

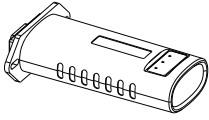

Datalogger (optional) x1

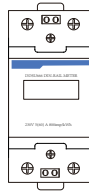

Meter (optional) x1

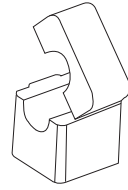

Sensor Clamp (optional) x1

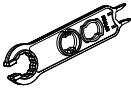

Solar Photovoltaic  
Connector Special  
Spanner x1

## 1.4 Product handling requirements

Lift the inverter out of the packaging box and transport it to the designated installation location.

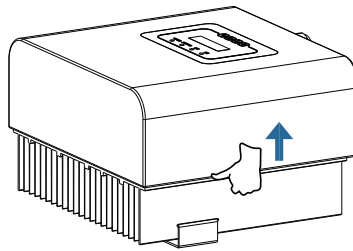

transport



### CAUTION:

Improper handling may cause personal injury!

- Arrange an appropriate number of personnel to carry the inverter according to its weight, and installation personnel should wear protective equipment such as anti-impact shoes and gloves.
- Placing the inverter directly on a hard ground may cause damage to its metal enclosure. Protective materials such as sponge pad or foam cushion should be placed underneath the inverter.
- Move the inverter by one or two people or by using a proper transport tool.
- Move the inverter by holding the handles on it. Do not move the inverter by holding the terminals.

---

## 2. Safety warnings and instructions

Improper use may result in potential electric shock hazards or burns. This manual contains important instructions that should be followed during installation and maintenance. Please read these instructions carefully before use and keep them for future reference.

### 2.1 Safety signs

Safety symbols used in this manual, which highlight potential safety risks and important safety information, are listed as follows:



**Warning:**

Warning symbol indicates important safety instructions, which if not correctly followed, could result in serious injury or death.



**Shock Hazard:**

Caution, risk of electric shock symbol indicates important safety instructions, which if not correctly followed, could result in electric shock.



**Safety Hint:**

Note symbol indicates important safety instructions, which if not correctly followed, could result in some damage or the destruction of the inverter.



**High Temperature Hazard:**

Caution, hot surface symbol indicates safety instructions, which if not correctly followed, could result in burns.

### 2.2 Safety instructions



**Warning:**

Electrical installation of the inverter must conform to the safety operation rules of the country or local area.

**Warning:**

Inverter adopts non-isolated topology structure, hence must insure DC input and AC output are electrical isolated before operating the inverter.

**Shock Hazard:**

Prohibit disassembling inverter case, there existing shock hazard, which may cause serious injury or death, please ask qualified person to repair.

**Shock Hazard:**

When PV module is exposed to sunlight, the output will generate DC voltage. Prohibit touching to avoid shock hazard.

**Shock Hazard:**

While disconnect the input and output of the inverter for maintenance, please waits for at least 5 mins until the inverter discharge the remnant electricity.

**High Temperature Hazard:**

Local temperature of inverter may exceed 80°C while under operating. Please do not touch the inverter case.

## 2.3 Notes for using

The single phase string power inverter is designed and tested under related safety regulations. It can ensure the personal safety of the user. But as a electric device, it may cause shock or injury by incorrect operation. Please operate the unit under below requirements:

1. Inverter should be installed and maintained by qualified person under local standard regulations.
2. Must disconnect the AC side first, then disconnect DC side while doing installation and maintenance, after that, please wait at least 5 mins to avoid getting shocked.
3. Local temperature of the inverter may exceed 80 °C while under operating. Do not touch to avoid getting injured.
4. All electrical installation must be in accord with local electrical standards, and after obtaining the permission of the local power supply department, the professionals can connect the inverter to the grid.
5. Please take appropriate anti-static measure.
6. Please install where children can not touch.
7. The steps to start the inverter: 1) switch on the AC side circuit breaker, 2) Switch on the DC side circuit breaker of the PV panel. 3) Turn on the DC switch of the inverter.  
The steps to stop the inverter: 1) switch off the AC side circuit breaker, 2) switch off the DC side circuit breaker of the PV panel. 3) Turn off the DC switch of the inverter.

8. Don't insert or remove AC and DC terminals when the inverter is in normal operation.

9. The DC input voltage of the inverter must not exceed the maximum value of the model.



### 3. Operation Interface

#### 3.1 Interface View

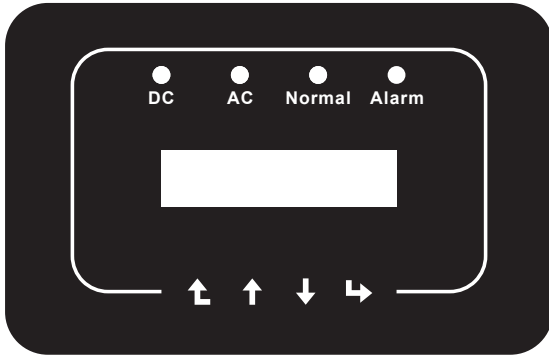

Pic 3.1 Front panel display

#### 3.2 Status Indicator

There are four LED status indicator lights in the front panel of the inverter. Please see table 3.1 for details.

Indicator	status	Explanation
● DC	on	Inverter detects DC input
	off	Low DC input voltage
● AC	on	Grid Connected
	off	Grid Unavailable
● NORMAL	on	Under normal operating
	off	Stop operating
● ALARM	on	Detected faults or report faults
	off	Under normal operating

Table 3.1 Status indicator lights

---

### 3.3 Buttons

There are four keys in the front panel of the Inverter(from left to right): Esc, Up, Down and Enter keys. The keypad is used for:

- Scrolling through the displayed options (the Up and Down keys);
- Access to modify the adjustable settings (the Esc and Enter keys).



### 3.4 LCD Display

The two-line Liquid Crystal Display (LCD) is located on the front panel of the Inverter, which shows the following information:

- Inverter operation status and data;
- Service messages for operator;
- Alarm messages and fault indications.

## 4. Product installation

### 4.1 Select installation location

To select a location for the inverter, the following criteria should be considered:

**WARNING: Risk of fire**

- Do not install the inverter in areas containing highly flammable materials or gases.
- Do not install the inverter in potentially explosive atmospheres.
- Do not install in small closed spaces where air can not circulate freely. To avoid overheating, always make sure the flow of air around the inverter is not blocked.
- Exposure to direct sunlight will increase the operational temperature of the inverter and may cause output power limiting. It is recommended that inverter installed to avoid direct sunlight or raining.
- To avoid overheating ambient air temperature must be considered when choosing the inverter installation location. It is recommended that using a sun shade minimizing direct sunlight when the ambient air temperature around the unit exceeds 104°F/40°C.



- Install on a wall or strong structure capable of bearing the weight.
- Install vertically with a maximum incline of +15°. If the mounted inverter is tilted to an angle greater than the maximum noted, heat dissipation can be inhibited, and may result in less than expected output power.
- If install more than one inverter, must leave at least 500mm gap between each inverter. And two adjacent inverters are also separated by at least 500 mm. And must install the inverter at the place where children cannot touch. Please see picture 4.3.
- Consider whether the installation environment is helpful to see the inverter LCD display and indicator status clearly.
- Must offer a ventilate environment if inverter installed in the airtight house.



**Safety Hint:**

Do not place or store any items next to the inverter.

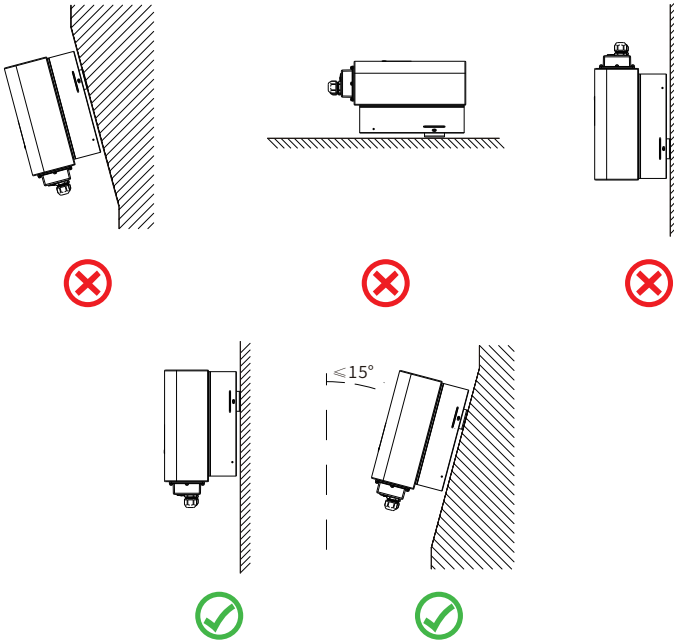

Pic 4.2 Installation Angle

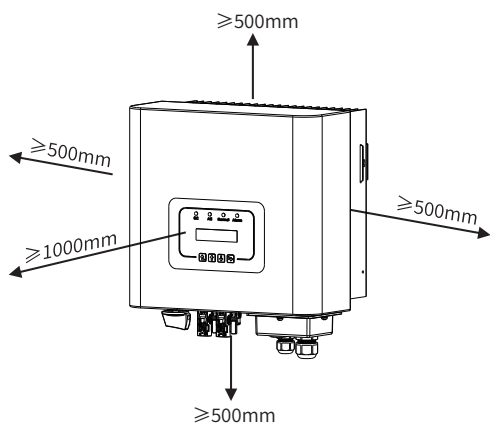













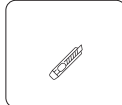
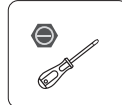
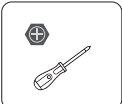
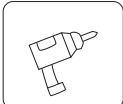

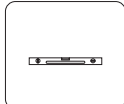
Pic 4.3 Installation Gap

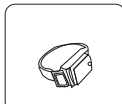
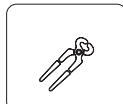
## 4.2 Installations Tools

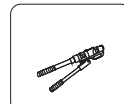
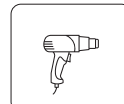
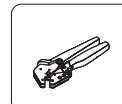
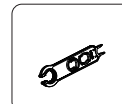
Installation tools can refer to the following recommended ones. Also, use other auxiliary tools on site.

table 4-1 Tool specification

						
Protective goggles	Earplugs	Anti-dust mask	Work gloves	Work shoes	Utility Knife	Slotted screwdriver
						
Cross screwdriver	Percussion drill	Pliers	Marker	Level	Rubber hammer	socket wrenches set
						
Anti-static wrist strap	Wire cutter	Wire stripper	Hydraulic pliers	Heat gun	Crimping tool4-6mm <sup>2</sup>	Solar connector wrench
						
Multimeter ≥1100 Vdc	RJ45 crimping plier	Cleaner				

### 4.3 Inverter Installation

The inverter is designed according to the wall mounted type installation, please use the wall mounted (the brick wall of the expansion bolt) when installing.

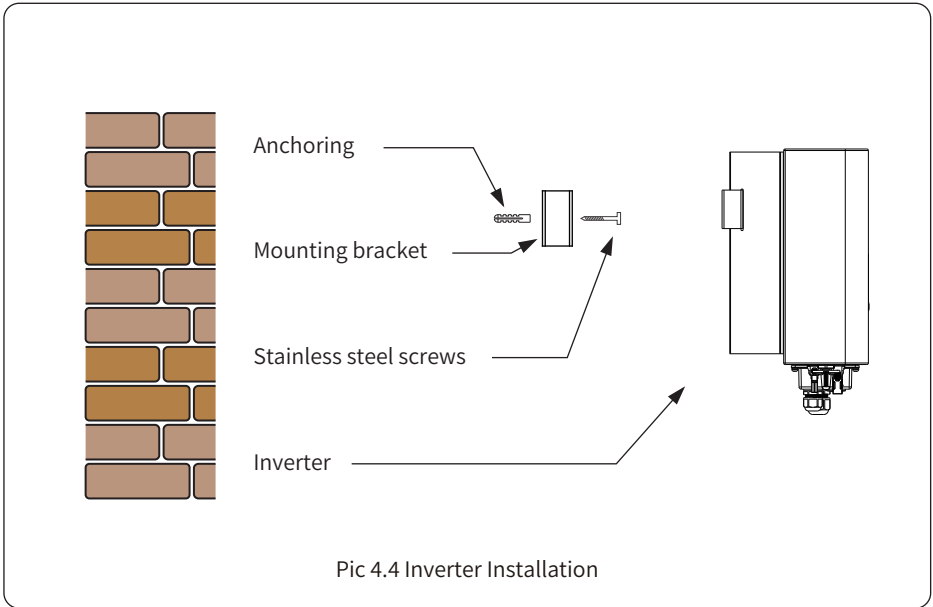

Procedure shows below:

1. Locate on the appropriate wall according to the bolt position on the mounting bracket, then mark the hole. On the brick wall, the installation must be suitable for the expansion bolt installation.

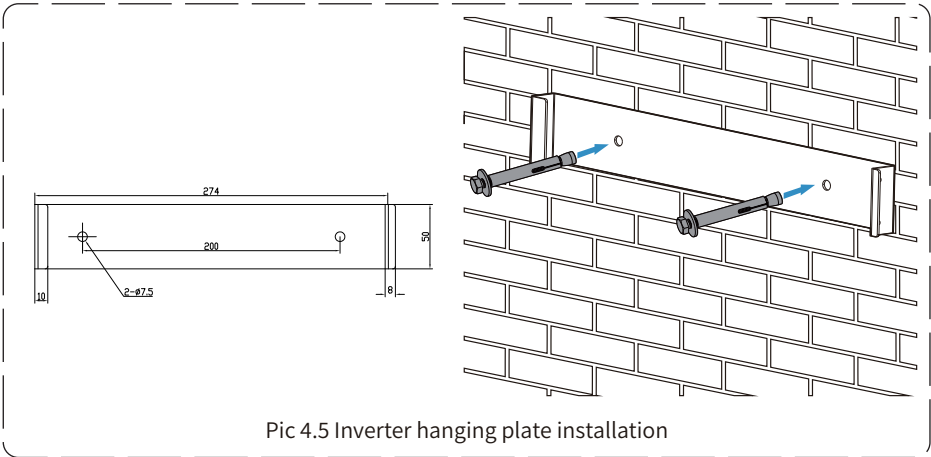

Pic 4.5 Inverter hanging plate installation

2. Ensure that the position of the installation holes on the wall is in accordance with the mounting plate, and the mounting rack is vertically placed.
3. Hang the inverter to the top of the mounting rack and then use the M4 screw in the accessory to lock inverter heat sink to the hanging plate, to ensure that the inverter will not move.

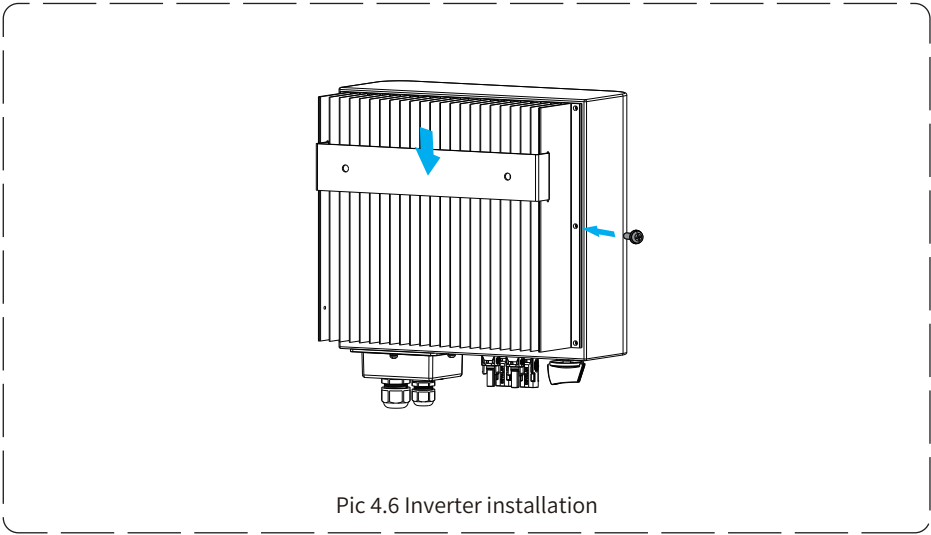

Pic 4.6 Inverter installation

## 5. Electrical Connection

### 5.1 PV Module Selection:

When selecting proper PV modules, please be sure to consider below parameters:

- 1) Open circuit Voltage (Voc) of PV modules not exceeds max. PV array open circuit voltage of inverter.
- 2) Open circuit Voltage (Voc) of PV modules should be higher than min. start voltage.
- 3) The PV modules used to connected to this inverter shall be Class A rating certified according to IEC 61730.

Inverter Model	3.6K	4K	4.2K	4.6K	5K	5.2K	6K	6.2K
Start-up DC Input Voltage(V)	80V							
Max.DC Input Voltage(V)	550V							
PV Array MPPT Voltage Range	70V-500V							
No. of MPP Trackers	2							
No. of Strings per MPP Tracker	1+1							

### 5.2 DC input terminal connection

1. Switch the Grid Supply Main Switch(AC)OFF.
2. Switch the DC Isolator OFF.
3. Assemble PV input connector to the inverter.



**Warning:**

When using PV modules, please ensure the PV+ & PV- of solar panel is not connected to the system ground bar.



**Safety Hint:**

Before connection, please make sure the polarity of the output voltage of PV array matches the “DC+” and “DC-” symbols.



**Warning:**

Before connecting inverter, please make sure the PV array open circuit voltage is within the 550V of the inverter.



Pic 5.1 DC+ male connector

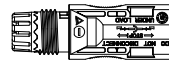

Pic 5.2 DC- female connector





**Safety Hint:**  
Please use approved DC cable for PV system.

Cable type	Cross section (mm <sup>2</sup> )	
	Range	Recommended value
Industry generic PV cable (model: PV1-F)	2.5-4 (12-10AWG)	2.5(12AWG)

Table 5.1 DC Cable Specifications

The steps to assemble the DC connectors are listed as follows:

a) Strip off the DC wire about 7mm, disassemble the connector cap nut (see picture 5.3).

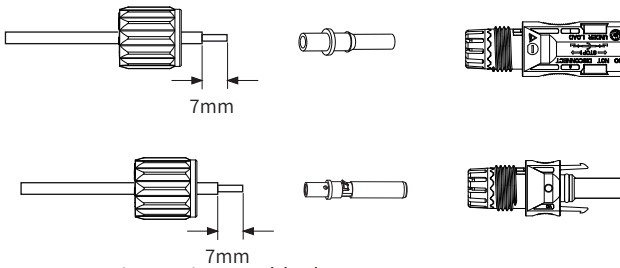

Pic 5.3 Disassemble the connector cap nut

b) Crimping metal terminals with crimping pliers as shown in picture 5.4.

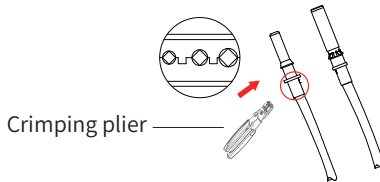

Pic 5.4 Crimp the contact pin to the wire

c) Insert the contact pin to the top part of the connector and screw up the cap nut to the top part of the connector. (as shown in picture 5.5).

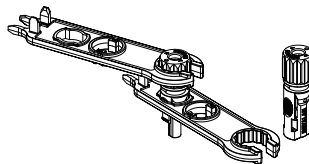

Pic 5.5 connector with cap nut screwed on

d) Finally insert the DC connector into the positive and negative input of the inverter, shown as picture 5.6.

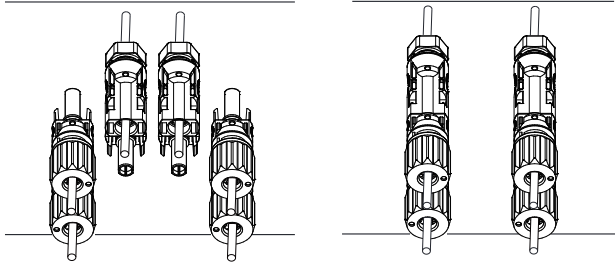

Pic 5.6 DC input connection



**Warning:**

Sunlight shines on the panel will generate voltage, high voltage in series may cause danger to life. Therefore, before connecting the DC input line, the solar panel needs to be blocked by the opaque material and the DC switch should be 'OFF', otherwise, the high voltage of the inverter may lead to life-threatening conditions.



**Warning:**

Please use its own DC power connector from the inverter accessories. Do not interconnect the connectors of different manufacturers. Max. DC input current should be 20A. if exceeds, it may damage the inverter and it is not covered by Deye warranty.

### 5.3 AC input terminal connection

Do not close the DC switch immediately after the DC terminal has been connected. Connect the AC wires to the AC terminals on the AC side of the inverter. Flexible wires are recommended for easy installation, as shown in Table 5.2.



**Warning:**

Prohibit using a single circuit breaker for multiple inverters, prohibit the connection of load between inverter circuit breakers.

Model	Cable CSA	AWG	Breaker	Max cable length
SUN-3.6K-G05P1-EU-AM2	2.5mm <sup>2</sup>	12	32A/400V	Outside cable (L+N+PE)20m
SUN-4K-G05P1-EU-AM2	2.5mm <sup>2</sup>	12	32A/400V	
SUN-4.2K-G05P1-EU-AM2	2.5mm <sup>2</sup>	12	32A/400V	
SUN-4.6K-G05P1-EU-AM2	2.5mm <sup>2</sup>	12	32A/400V	
SUN-5K-G05P1-EU-AM2	2.5mm <sup>2</sup>	12	32A/400V	
SUN-5.2K-G05P1-EU-AM2	4.0mm <sup>2</sup>	10	32A/400V	

Model	Cable CSA	AWG	Breaker	Max cable length
SUN-6K-G05P1-EU-AM2	4.0mm <sup>2</sup>	10	40A/400V	Outside cable (L+N+PE)20m
SUN-6.2K-G05P1-EU-AM2	4.0mm <sup>2</sup>	10	40A/400V	

Table 5.2 Cable information

## 5.4 The connection of the ground line

Good grounding is good for resisting surge voltage shock and improving EMI performance. Therefore, before connecting AC, DC and communication cables, you need to ground the cable firstly. For a single system, just ground the PE cable. For multiple machine systems, all PE cables of the inverter need to be connected to the same grounding copper platoon to ensure the equipotential connection. The installation of the shell ground wire is shown as picture 5.11. The external protective earthing conductor is made of the same metal as the phase conductor.

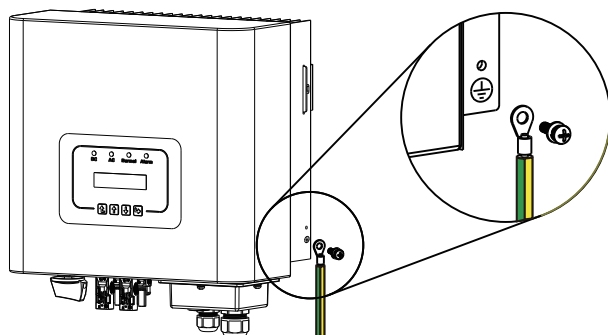

Pic 5.11 The installation of the shell ground wire

Model	Wire Size	Cable(mm <sup>2</sup> )	Torque value(max)
3.6/4/4.2/4.6/5KW	12AWG	2.5mm <sup>2</sup>	8.5Nm
5.2/6/6.2KW	10AWG	4.0mm <sup>2</sup>	8.5Nm



### Warning:

Inverter has built-in leakage current detection circuit, The type A RCD can be connected to the inverter for protection according to the local laws and regulations. If an external leakage current protection device is connected, its operating current must be equal to 300 mA or higher, otherwise inverter may not work properly.

## 5.5 Max. over current protection device

In order to protect the inverter AC connection, it is recommended to install a circuit breaker to prevent overcurrent. See table 5.3 below.

Inverter	Rated output voltage(V)	Rated output current(A)	Current for protection device(A)
SUN-3.6K-G05P1-EU-AM2	220/230	16.4/15.7A	32
SUN-4K-G05P1-EU-AM2	220/230	18.2/17.4A	32
SUN-4.2K-G05P1-EU-AM2	220/230	19.1/18.3A	32
SUN-4.6K-G05P1-EU-AM2	220/230	21.0/20.0A	32
SUN-5K-G05P1-EU-AM2	220/230	22.8/21.8A	32
SUN-5.2K-G05P1-EU-AM2	220/230	23.7/22.7A	32
SUN-6K-G05P1-EU-AM2	220/230	27.3/26.1A	40
SUN-6.2K-G05P1-EU-AM2	220/230	28.2/27.0A	40

Table 5.3 Recommended current protector specifications

## 5.6 Inverter monitoring connection

Inverter has the function of wireless remote monitoring. The inverter with Wi-Fi function is equipped with Wi-Fi Plug to connect the inverter and network. Wi-Fi Plug's operation, installation, Internet access, APP downloading and other processes are detailed in the instructions.

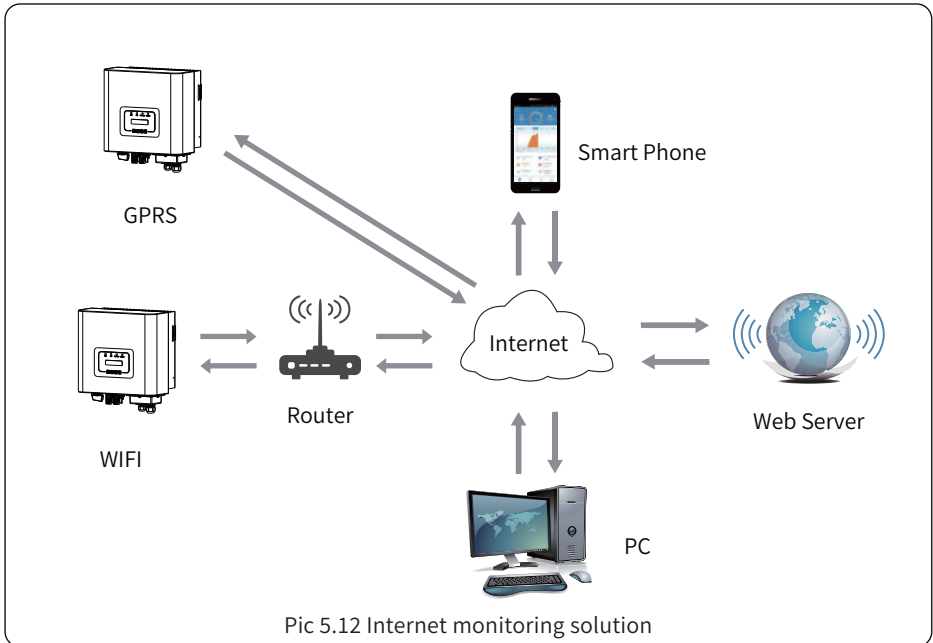

Pic 5.12 Internet monitoring solution

## 5.7 Installation of datalogger

When the inverter is out of the factory, the installation location of datalogger is sealed by a plate as shown in Picture 5.13. When installing the datalogger, remove the sealing plate, insert the datalogger into the interface and fix it with screws. The configuration of the datalogger needs to be performed after various electrical connections have been completed and the inverter is powered on by DC power. When the inverter has been powered on by DC power, it's able to check whether the datalogger is normally electrified or not through the status of LED light(The LED light shines out of the shell).

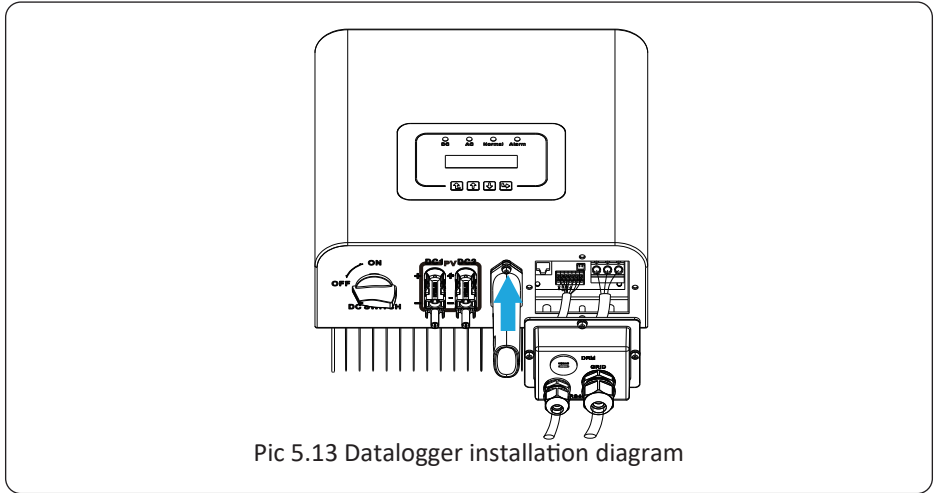

Pic 5.13 Datalogger installation diagram

## 5.8 Configuration of datalogger

For the configuration of datalogger, please refer to illustrations of the datalogger.

## 6. Startup and Shutdown

Before starting the inverter, make sure that the inverter can meet the following conditions, otherwise it may result in fire or damage to the inverter. In this case, we do not undertake any responsibility. At the same time, to optimize the system configuration, it is recommended that the two inputs be connected to the same number of photovoltaic modules.

- a). The maximum open circuit voltage of each set of photovoltaic modules shall not exceed 550Vdc under any conditions.
- b). Each input of the inverter better use the same type of photovoltaic module in series.
- c). Total output power of PV shall not exceed the maximum input power of inverter, each photovoltaic modules shall not exceed the rated power of each channel.

## 6.1 Start up the inverter

When starting up the Single Phase String Power Inverter , should follow steps below:

1. Starting switch on the AC breaker.
2. Turn on the DC switch of the PV module, and if the panel provides sufficient starting voltage and power, the inverter will start.
3. The inverter will first check the internal parameters and the grid parameters, while the liquid crystal will show that the inverter is self-checking.
4. If the parameter is within acceptable range, the inverter will generate energy.  
NORMAL indicator light is on.

## 6.2 Inverter Shutdown

Must follow below steps while shutting down the inverter:

1. Switch off the AC breaker.
2. Wait for 30 seconds, turn off the DC switch (if any). The inverter will close the LCD and all indicators within two minutes.

## 6.3 Anti-PID Function(option)

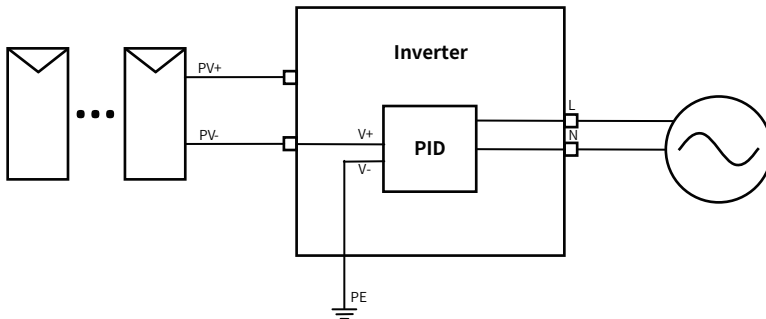

The Anti-PID module repairs the PID effect of the PV module at night. The PID module always runs when connected to AC.

If maintenance is required and turn off the AC switch can disable the Anti-PID function.



### WARNING:

The PID functionality is automatic. When the DC bus voltage is below 50VDC, the PID module will create 450VDC between the PV and ground. No control and equipment are required.



### WARNING:

If you need to maintain the inverter, Please turn off the AC switch first, then turn off the DC switch, and wait 5 minutes before you do other operations.

## 7. Zero-export function via energy meter

When you are reading this, we believe that you have completed the connection according to the requirements of chapter 5, if you have been running your inverter at this time, and you want to use the zero-export function, please turn off AC and DC switch of the inverter, and wait for 5 minutes until the inverter completely discharged. Please follow below Pic 7.1 & Pic 7.18 to connect the energy meter.

For system wiring diagram, the red line refers to L line (L), the blue line refers to the neutral line (N), green line refers to ground wire (PE). Connecting energy meter RS485 cable to inverter's RS485 port. It's recommended to install an AC switch between the inverter and the utility grid, the specs of the AC switch are determined by the power of load.

The AC switch we recommend to connect to the inverter output can refer to Table 5.2. If there is no integrated DC switch inside the inverter you purchased, we commend you to connect the DC switch. The voltage and current of the switch depend on the PV array you access.

### System connection diagram for the Eastron meter

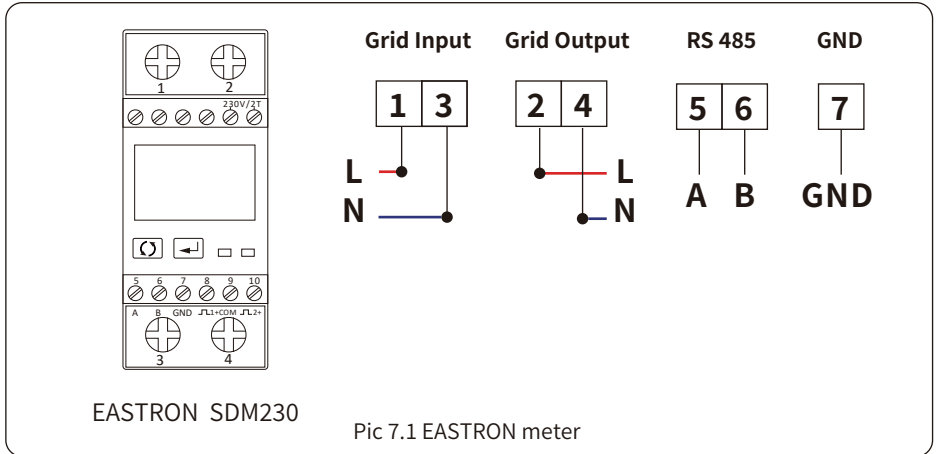

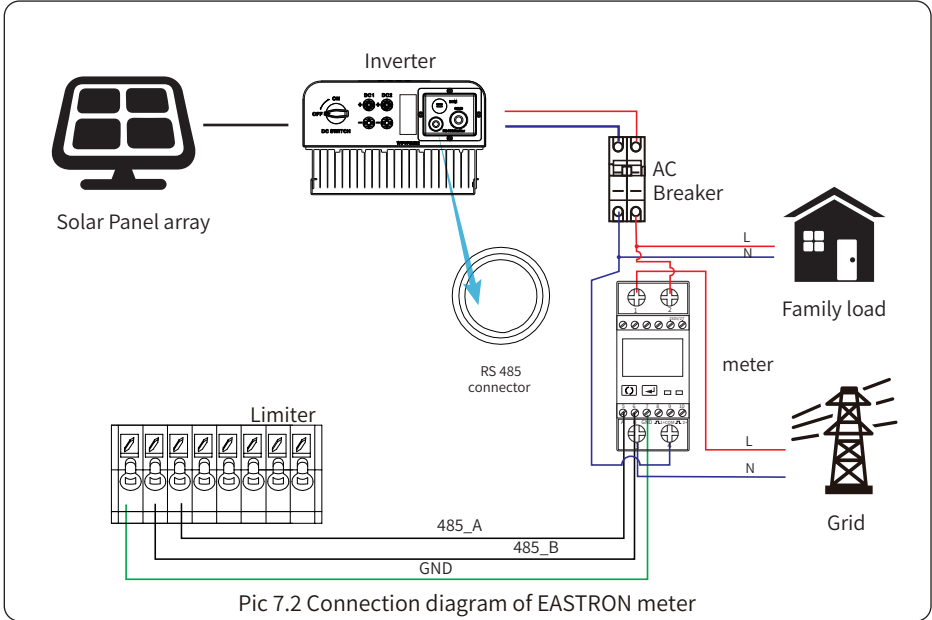

Pic 7.2 Connection diagram of EASTRON meter



Pic 7.3 Parameter setting

When the EASTRON meter connected successfully, it will shows SN: 2



**Safety Hint:**

Ensuring grid input cables connect 1&3 port of energy meter, and inverter AC output cables connect 2&4 port of energy meter when connecting.



**Warning:**

In final installation, breaker certified according to IEC 60947-1 and IEC 60947-2 shall be installed with the equipment.



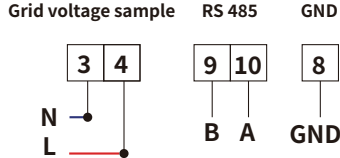
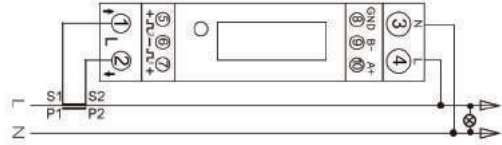
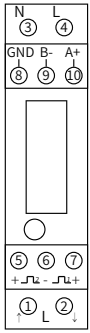

SDM120CTM-40mA  
(ESCT-TA16 120A/40mA)

Pic 7.4 EASTRON meter

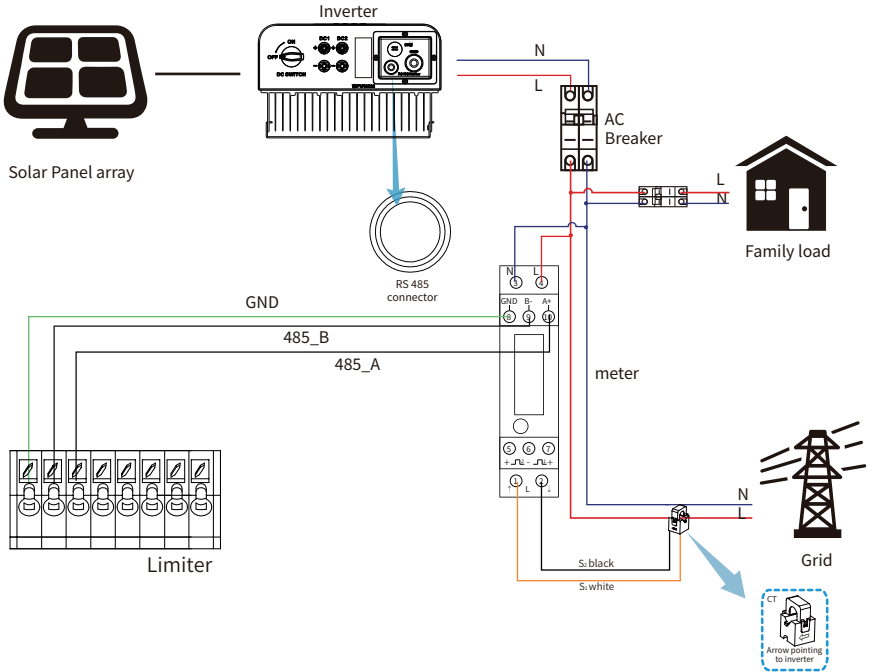

Pic 7.5 Connection diagram of EASTRON meter

# System connection diagram for the CHNT meter

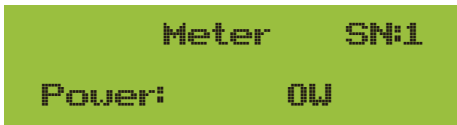
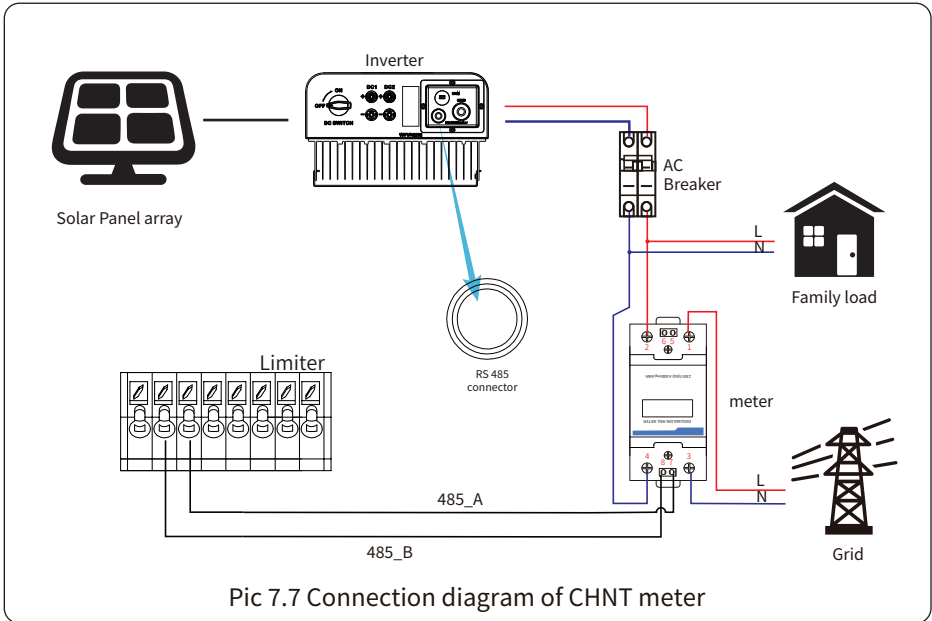
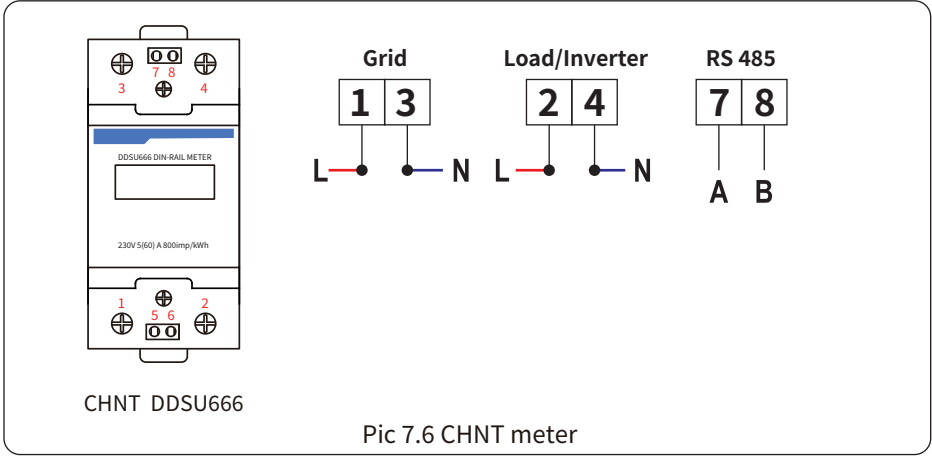

## Pic 7.8 Parameter setting

When the CHNT meter connected successfully, it will shows SN: 1

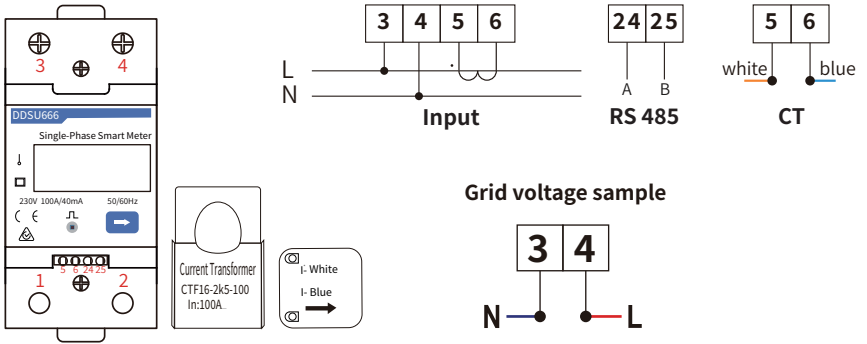

DDSU666-CT  
(CTF16-2K5-100A)

Pic 7.9 CHNT meter

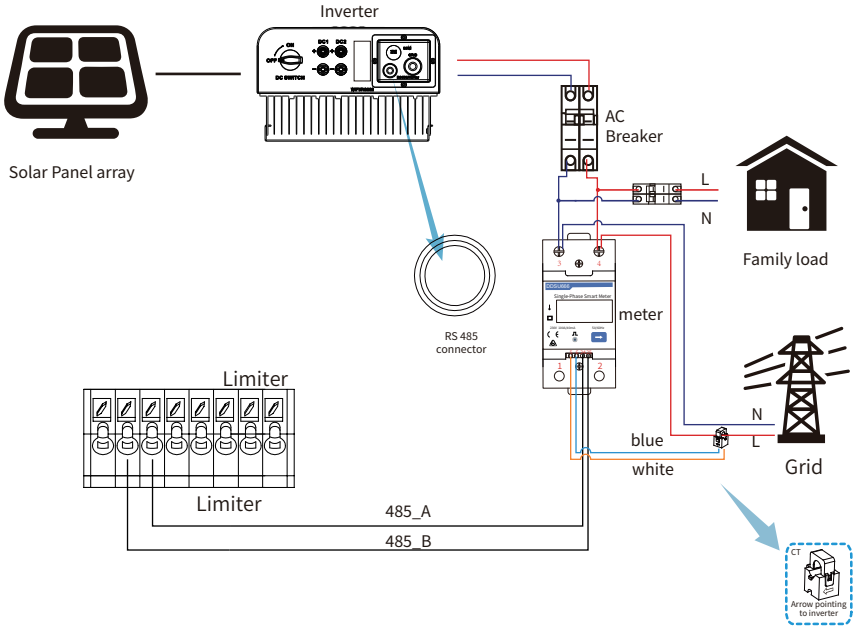

Pic 7.10 Connection diagram of CHNT meter

# System connection diagram for the Eastron meter

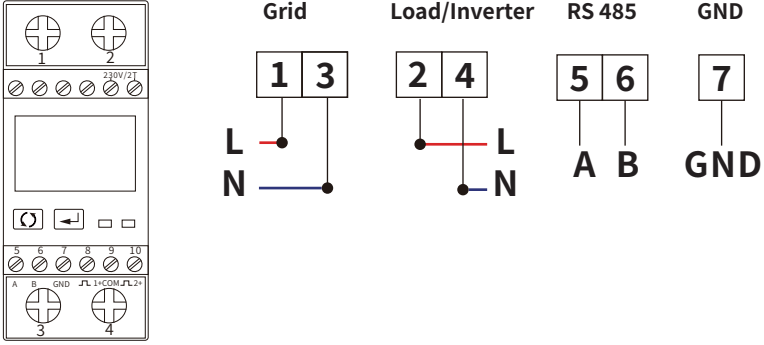

EASTRON SDM230

Pic 7.11 EASTRON meter

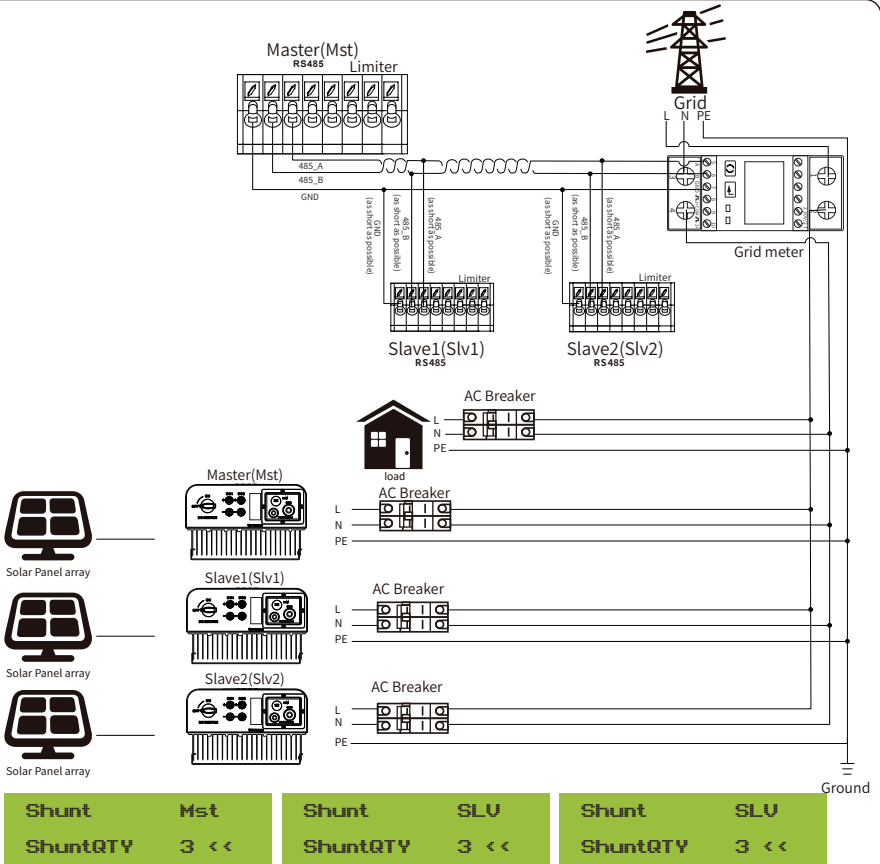

Pic 7.12 Eastron Connection diagram(The pass-through table)

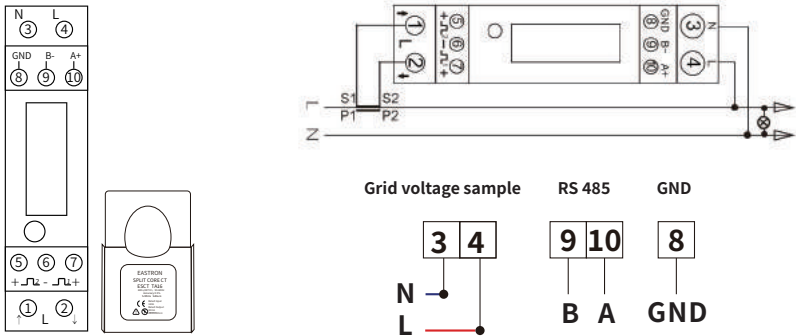

SDM120CTM-40mA  
(ESCT-TA16 120A/40mA)

Pic 7.13 EASTRON meter

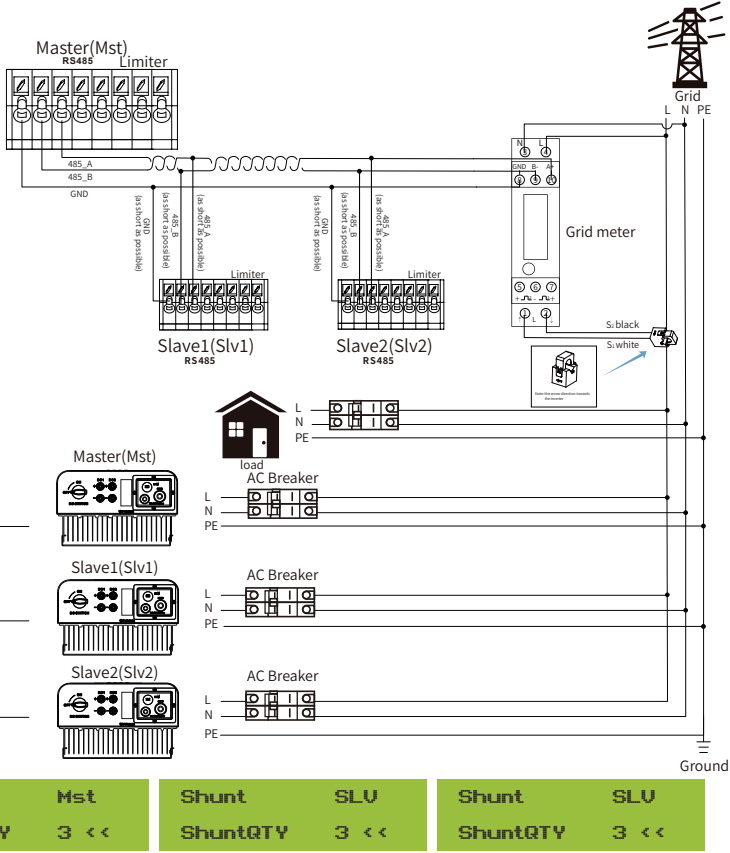

Shunt	Mst	Shunt	SLU	Shunt	SLU
ShuntQTY	3 <<	ShuntQTY	3 <<	ShuntQTY	3 <<

Pic 7.14 Eastron Connection diagram(The pass-through table)

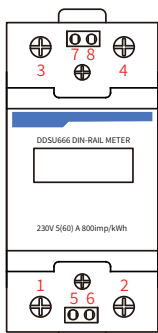

CHNT DDSU666

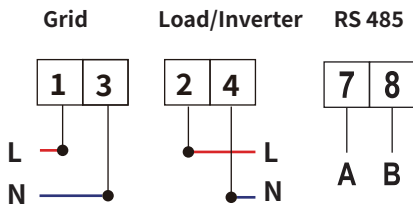

Pic 7.15 CHNT meter

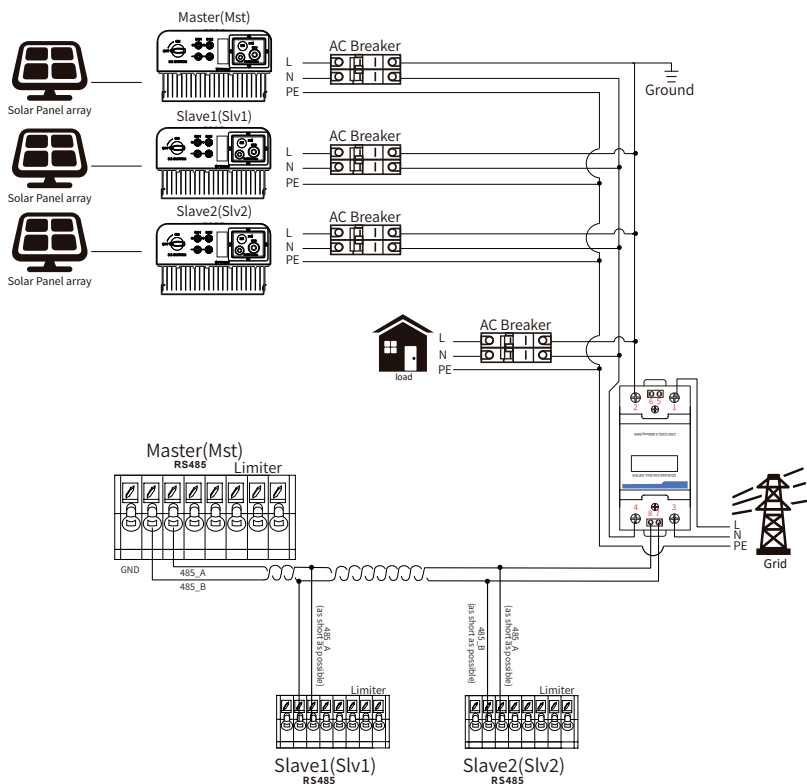

Shunt	Mst	Shunt	SLU	Shunt	SLU
ShuntQTY	3 <<	ShuntQTY	3 <<	ShuntQTY	3 <<

Pic 7.16 CHNT Connection diagram(The pass-through table)

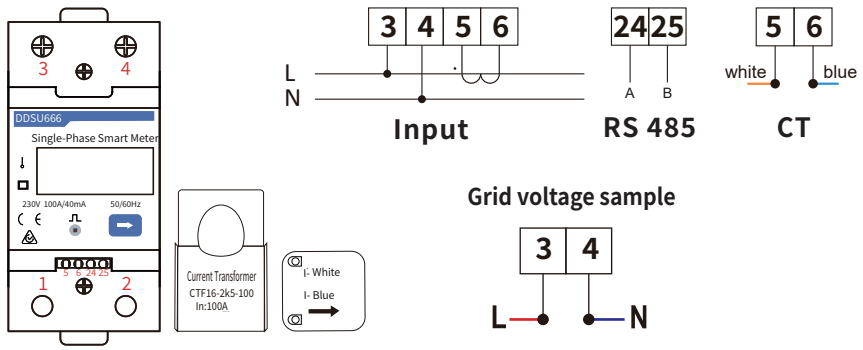

DDSU666-CT  
(CTF16-2K5-100A)

Pic 7.17 CHNT meter

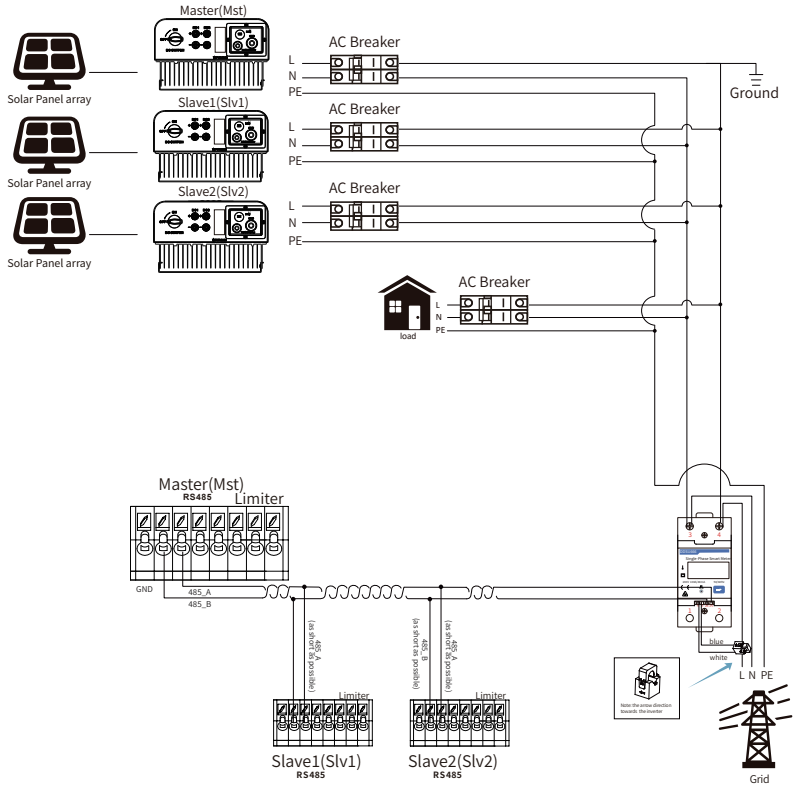

Shunt	Mst	Shunt	SLV	Shunt	SLV
ShuntQTY	3 <<	ShuntQTY	3 <<	ShuntQTY	3 <<

Pic 7.18 CHNT Connection diagram(The pass-through table)

## 7.1 Use of zero-export function

When the connection is completed, the following steps should be referred to use this function:

1. Turn on the AC switch.
2. Turn on the DC switch, waiting for the inverter's LCD is turned on.
3. Press Enter button on the LCD panel in the main interface into the menu options, select [parameter setting] to enter setup submenu, and then select [running parameters] as shown in picture 7.19, at this time please input the default password 1234 through pressing the button [up down, enter], enter the operation parameter setting interface, shown as picture 7.20.

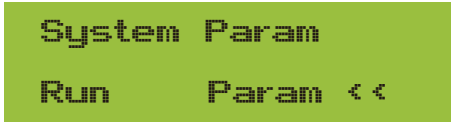

Pic 7.19 Parameter setting



Pic 7.20 Meter switch

4. Operate the button [up down], move setting cursor to energy meter and press the button [enter]. At this time you can turn on or turn off the energy meter by choosing [up down] button, please press [enter] button to confirm when setting done.
5. Move the cursor to [OK], press [enter] to save the settings and exit the running parameters page, otherwise the settings are invalid.
6. If set up successfully, you can return to the menu interface, and display the LCD to [home page] by press the [up down] button. If it displays [meter power XXW], the zero-export function setting is completed. Shown as picture 7.21.



Pic 7.21 Zero-export function via energy meter turn on

7. Meter power XXW shows positive means grid is supplying the load, and no power fed into grid. if meter power shows negative, it means PV energy is being sold to grid.
8. After properly connection is done, wait for inverter starting. If the power of the PV array meets the current power consumption, the inverter will keep a certain output to counteract the power of the grid without backflow .

## 7.2 Sensor Clamp(optional)

The inverter has integrated export limitation function.The function is to adjust the output of inverter quickly according to the power of the user and solar panels, prevent the output of the inverter from being fed to the power grid. This limiter function is optional. If you buy the inverter with limiter, a current sensor will be included in the package which is necessary for limiter function.



## 7.2.1 Zero-export function via CT

When you are reading this, we believe that you have completed the connection according to the requirements of chapter 5, if you have been running your inverter at this time, and you want to use the limiter function, please turn off AC and DC switch of the inverter, and wait for 5 minutes until the inverter completely discharged. Then connect the current sensor to the inverter limiter interface. Make sure they are reliably connected, and the current sensor should clamp to the live wire of the incoming line. In order to make it easier for you to use the built-in limiter function of the inverter, we have specifically given the wiring diagram, as shown in Picture 7.23, the red lines connected to the utility grid said wire (L), blue line shows the zero line (N), yellow green line shows the ground wire (PE). We recommend installing a AC switch between the inverter outlet and the utility grid, the specs of the AC switch is determined according to the load capacity. The AC switch we recommend to connect to the inverter output can refer to Table 5.1. If there is no integrated DC switch inside the inverter you purchased, we commend you to connect the DC switch. The voltage and current of the switch depends on the PV array you access.

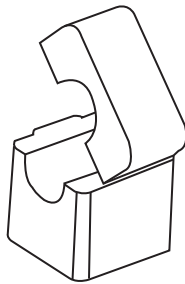

Pic 7.22 Sensor Clamp (The arrow of current sensor points to the grid)

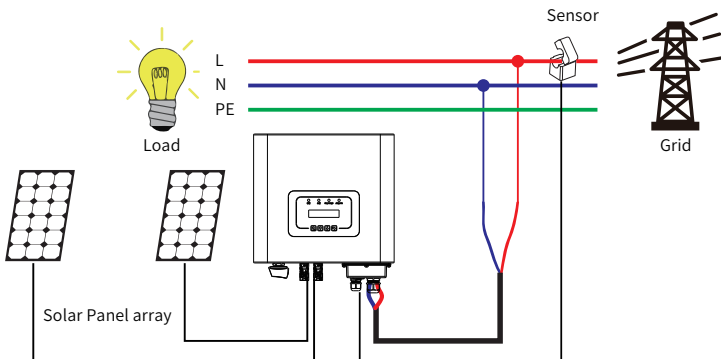

Pic7.23 Connection diagram of Sensor Clamp

### 7.3 Use of limiter function

When the connection is completed, the following steps should be referred to use this function:

1. Turn on the AC switch.
2. Turn on the DC switch, waiting for the inverter's LCD is turned on.
3. Press Enter button on the LCD panel in the main interface into the menu options, select [parameter setting] to enter setup submenu, and then select [running parameters] as shown in picture 7.24, at this time please input the default password 1234 through pressing the button [up down, enter], enter the operation parameter setting interface, shown as picture 7.25.



Pic 7.24 Parameter setting



Pic 7.25 Limit switch

4. Operate the button [up down], move setting cursor to limit function and press the button [enter]. At this time you can turn on or turn off the limit function by choosing [up down] button, please press [enter] button to confirm when setting done.
5. Move the cursor to [confirm] , press ENTER to save the settings and exit the running parameters page, otherwise the settings are invalid.
6. If set up successfully, you can return to the menu interface, and display the LCD to [home page] by press the [up down] button. If it displayed as [utility power], the limiter function settings will be completed. Shown as picture 7.26.



**\* This item is not available for some FW verison**

Pic 7.26 Limiter function turn on

7. [utility power] showing positive means grid power is consuming energy, and there is no backflow. If [utility power] shows negative, which means there' s excess PV energy flows to grid or current transformer arrow direction is in wrong direction. Please read more on chapter 7.
8. After properly connection is done, wait for inverter starting. If the power of the PV array meets the current power consumption, the inverter will maintain a certain output to counteract the power of the grid without backflow .

## 7.4 Notes while using zero export function

For your safety and the operation of limiter function of the inverter, we put forward the following suggestions and precautions:



### Safety Hint:

Under zero export mode we strongly recommend that the two PV arrays are formed by the same number of PV panels of the same size, which will make the inverter more responsive to limit the power.



### Safety Hint:

While the utility power is negative and inverter has no output power, that means the orientation of the current sensor is wrong, please turn off the inverter and change orientation of the current sensor.  
(when using limiter, the arrow of current sensor points to the grid)

## 7.5 How to browse the load power of your PV grid-tie plant on monitoring platform?

If you want to browse load power of the system and how much energy (KWH) does it export to grid (inverter output power is used to power the load firstly and then the surplus energy will feed into grid). You also need to connect the meter according to Pic 7.12. After the connection completed successfully, the inverter will show the load power on the LCD. **But please don't setup "Meter ON"**. Also, you will be able to browse the load power on the monitoring platform. The plant setting method as below description.

Firstly, go to the solarman platform (<https://pro.solarmanpv.com>, this link is for solarman distributor account; or <https://home.solarmanpv.com>, this link is for solarman end user account;) plant home page and click "edit"

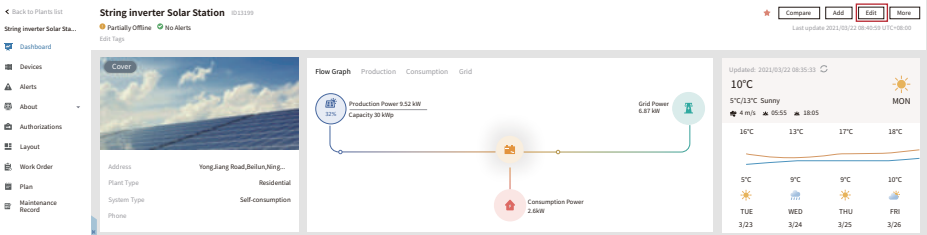

And then choose your system type as “Self-consumption”

Edit Plant Cancel Done

Basic Info  
System Info  
Yield Info  
Owner Info

\* Address: YongJiang Road, Beilun, Ningbo, 315806, China

\* Coordinates: Longitude 121 46 19.03 Latitude 29 53 36.11

Time Zone: (UTC+08:00) Beijing,Chongqing,Hong Kong,Urumqi  
Creation Time: 2020/04/08

---

System Info Collapse

Plant Type: Residential System Type: Self-consumption

\* Capacity(kWp): 30  
Address: 0-360

Secondly, go to plant page, if it shows the PV power, load power and grid power, which means the configuration is correct.

String inverter Solar Station 013399 Compare All Edit More  
Last update: 2021/03/22 09:40:53 (UTC+08:00)

Partially Offline No Alerts

Dashboard

Devices Alerts About Authorizations Layout Work Order Maintenance Record

Cover

Address: YongJiang Road, Beilun, Ning...  
Plant Type: Residential  
System Type: Self-consumption  
Phone:

Flow Graph Production Consumption Grid

Production Power 9.52 kW  
Capacity 30 kWp

Grid Power 6.87 kW

Consumption Power 2.6kW

Overview: 10°C, 5°C/12°C Sunny, 4 MW, 05:55 - 18:05, MON

16°C	13°C	17°C	18°C
5°C	9°C	9°C	10°C
TUE	WED	THU	FRI
3/23	3/24	3/25	3/26

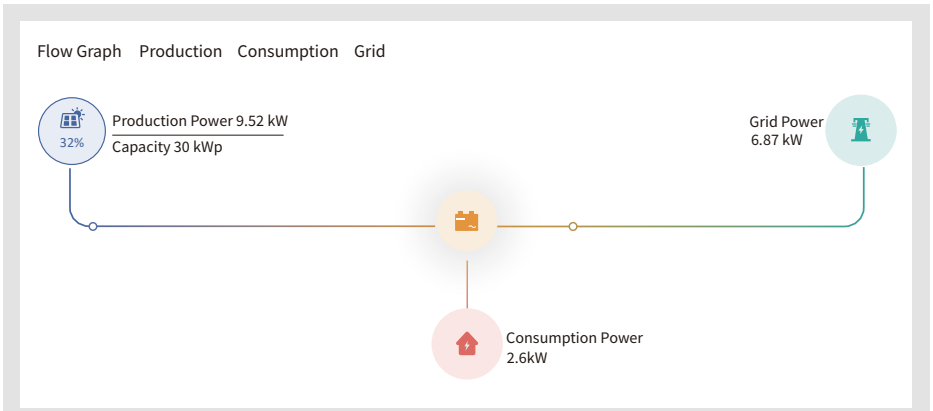

# 8. General Operation

During normal operation, the LCD shows the current status of the inverter, including the current power, total generation, a bar chart of power operation and inverter ID, etc. Press the Up key and the Down key to see the current DC voltage, DC current, AC voltage, AC current, inverter radiator temperature, software version number and Wifi connection state of the inverter.

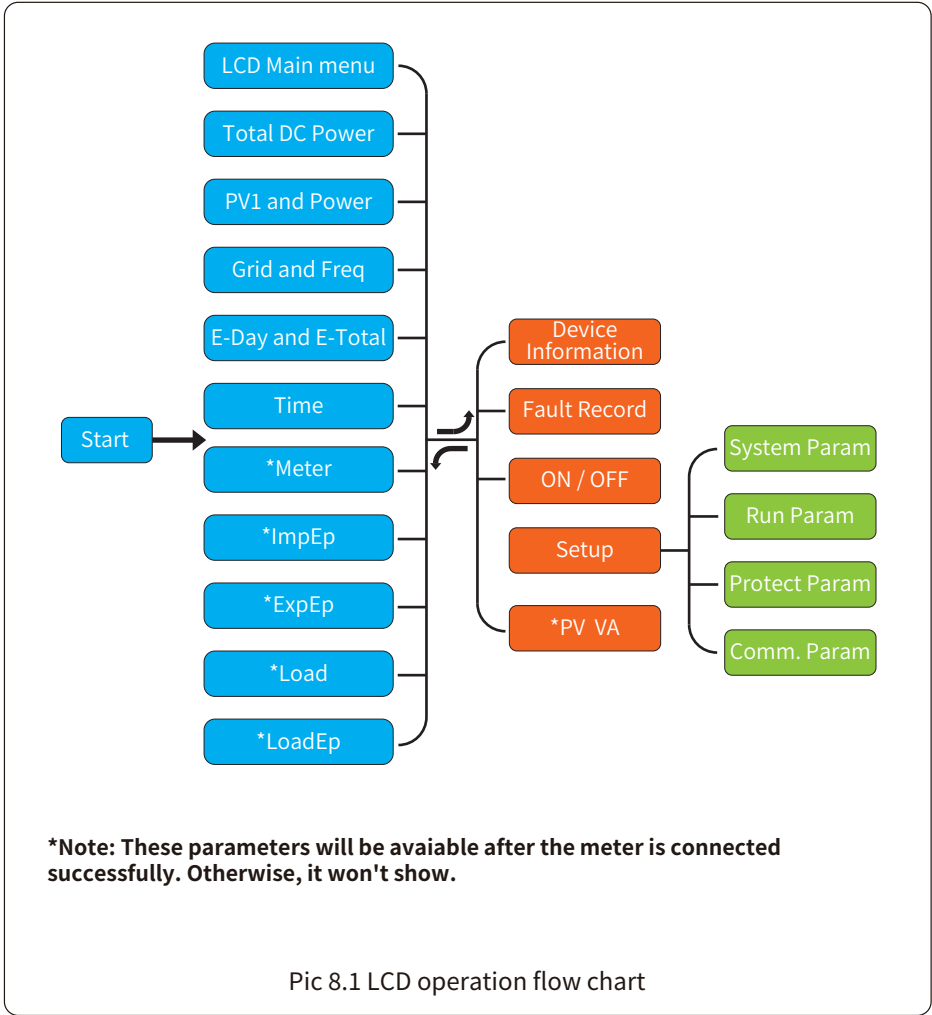

## 8.1 The initial interface

From the initial interface, you can check PV power, PV voltage, grid voltage, inverter ID, model and other information.



Pic 8.2 The initial interface

Press UP or Down, you can check inverter DC voltage, DC current, AC voltage, AC current and inverter radiator temperature(Temperature can only be seen by long pressing the button [ESC]. [enter] ).



Pic 8.3 PV input voltage and current information



Pic 8.4 AC running state information



Pic 8.5 Time



Pic 8.6 Meter power

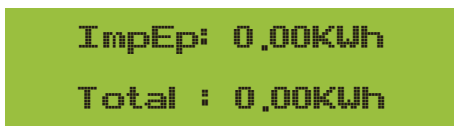

Pic 8.7 Electrical energy

ImpEp: Daily energy purchased from grid;  
Total: Total energy purchased from grid.

```
ExpEp: 0,00KWh
Total : 0,00KWh
```

ExpEp: Daily energy sold to grid;  
Total: Total energy sold to grid.

Pic 8.8 Electrical energy

```
Load
Power: 0W
```

Pic 8.9 Load power

```
LoadEp: 0,00KWh
Total : 0,00KWh
```

LoadEp: Daily consumption;  
Total: Total energy consumption.

Pic 8.10 Load consumption

```
E-Day : 0Wh
E-Total : 134KWh
```

E-Day: Daily generation;  
E-Total: Total generation.

Pic 8.11 PV generation

## 8.2 Submenus in the Main Menu

There are five submenus in the Main Menu.

### 8.2.1 Device information

Device Info, <<	GL3000 SN-01
Fault Record	PF:0,000
ID:2222224332	Inv1400
Inv1400	Lcd0238

Pic 8.12 Device information

You can see the LCD software Lcd0238 and Control Software Version Inv1400. In this interface, there are parameters such as rated power communication addresses.

## 8.2.2 Fault Record

It can keep eight fault records in the menu including time, customer can deal with it depends on the error code.



Pic 8.13 Fault Record

## 8.2.3 ON/OFF setting

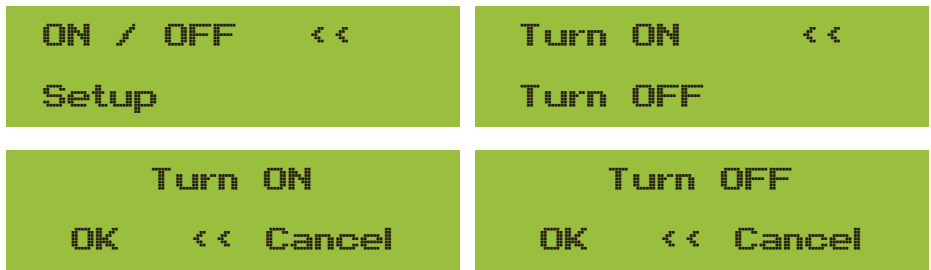

Pic 8.14 ON/OFF setting

When "Turn OFF" is selected and press "OK" to be checked, it will stop working immediately. And, it will be in Off status. When the "turn on" is ticked again, it will go to self-test program again. If it passed the selfcheck, it will start to work again.



### 8.2.4 Parameter setting

There are four submenus in the setup. Setting includes system param, run param, protect param, comm.param. All of these information for maintenance reference.

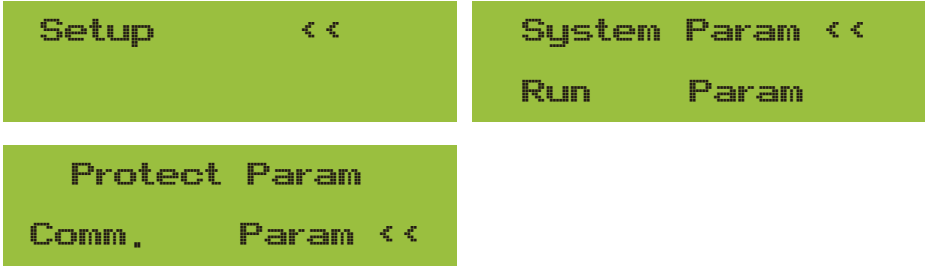

Pic 8.15 Submenus of the parameter setup

### 8.3 System param setting

System Param includes time set, language set, display set and factory reset.



Pic 8.16 System Param

20200522 OK  
08:11:21 Cancel

Pic 8.17 Time

English <<  
Polski

P CCK <<  
Nederland

Pic 8.18 Language

Bright Kepp <<  
Delay time 05S

Pic 8.19 LCD Screen settings

Delay time 05S  
OK << Cancel

Pic 8.20 Delay time set

Confirm Reset <<  
Cancel

Pic 8.21 Reset to factory setting

I Confirm <<  
Cancel

Pic 8.22 Set Restore

## 8.4 Running param setting



**Warning:**

Password required-- only for access-authorized engineer. Un-authorized access may avoid the warranty. The initial password is 1234.



**Warning:**

The "--"symbol at the bottom right corner indicates that the machine does not have this function.

PassWord

\* \* \* \*

Pic 8.23 Password

### 8.4.1 ActiveP setting



ActiveP: Adjust the output active power in %

Pic 8.24



ReactiveP: Adjust reactive power output in %

Pic 8.25



PF:Power Fator

Fun\_ISO: Insulation resistance detection

Pic 8.26



Fun\_RCD: Residual current detection

Self-check: Inverter's self-check time.The default value 60s

Pic 8.27



Island: Anti-islanding protection

Meter: Energy meter.If inverter will connect meter,then set here to ON

Pic 8.28

```

Exp_Mode      AUG
CT_Ratio      1 <<
  
```

```

Exp_Mode      MIN
CT_Ratio      1 <<
  
```

```

MFR           AUTO<-
Back          <<
  
```

```

MFR           ACREL<-
Back          <<
  
```

```

MFR           EASTRON<-
Back          <<
  
```

```

MFR           CHNT<-
Back          <<
  
```

Pic 8.29 Meter

```

Limiter       ON <<
Feed-in       0%
  
```

Feed\_In %: it is used to deploy how much power can be feed into grid.  
 For example, Feed\_in=50% of the 6W model, which means Max. 3KW power can be feed into grid.And, this parameter is valid only after connecting a meter and the meter function is "ON".

```

MPPT_Num     0
WindTurbine   <<
  
```

Pic 8.30

```

U1:  0.0V <-
      0.0A
  
```

```

U2:  0.0V <-
      0.0A
  
```

```

U3:  0.0V <-
      0.0A
  
```

```

U4:  0.0V <-
      0.0A
  
```

```

U5:  0.0V <-
      0.0A
  
```

```

U6:  0.0V <-
      0.0A
  
```

```

U7:  0.0V <-
      0.0A
  
```

```

U8:  0.0V <-
      0.0A
  
```

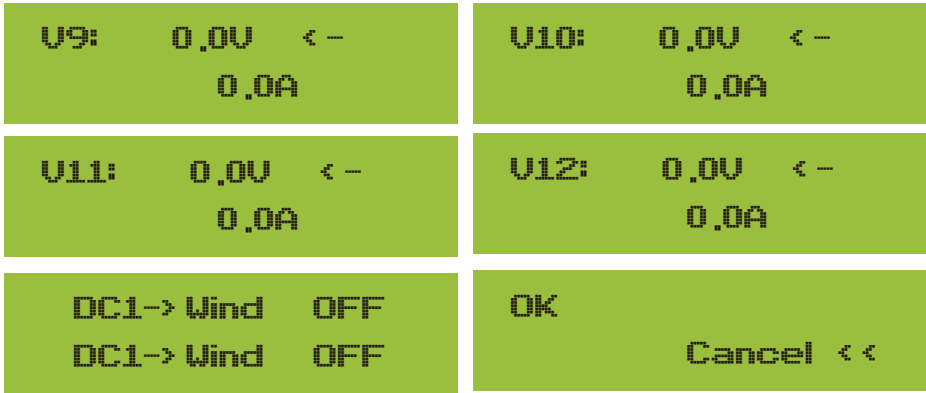

Pic 8.31 WindTurbine



Pic 8.32 Arc-Fault Detection

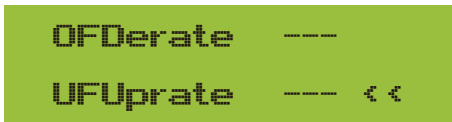

OFDerate:Over Frequency Derate  
UFUprate:Under Frequency Uprate



Pic 8.33 active power droop



## 8.5 Protect Param setting



**Warning:**

Engineer Only.

We will set the param depends on the safety requirements, so customers don't need to reset it. The password is same as 8.4 Running param



Pic 8.34 Password

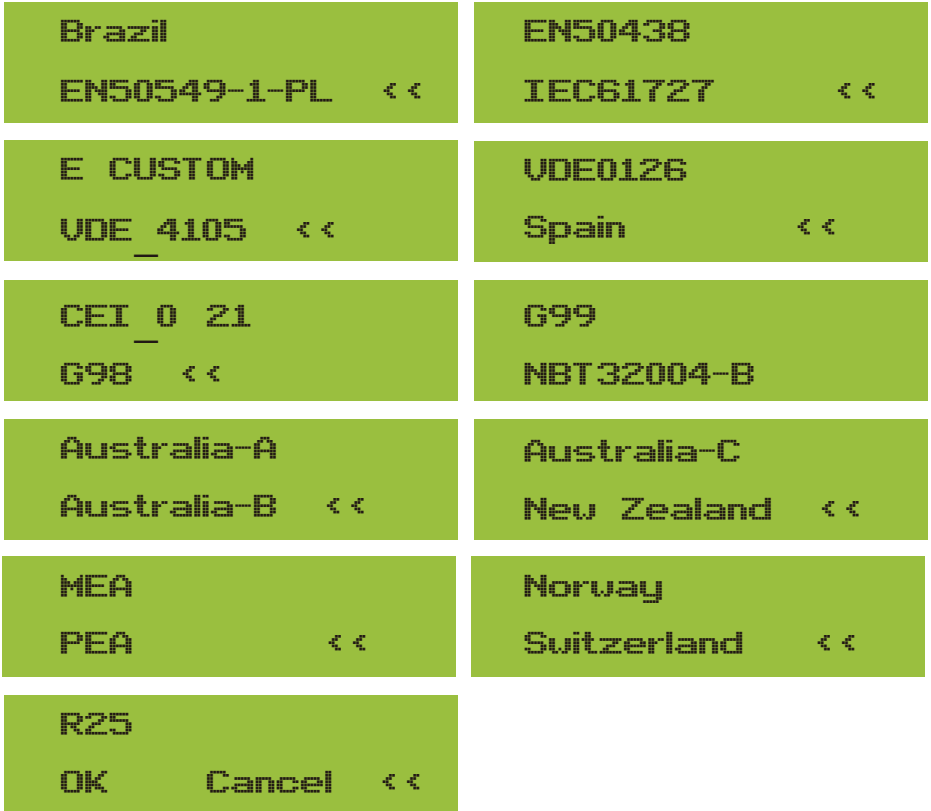

Pic 8.35 GirdStandard

OverVolt Lv3  
Point 240,0V <<

OverVolt Lv3  
Delay 1000ms <<

OverVolt Lv2  
Point 240,0V <<

OverVolt Lv2  
Delay 1000ms <<

OverVolt Lv1  
Point 240,0V <<

OverVolt Lv1  
Delay 1000ms <<

UnderVolt Lv1  
Point 235,0V <<

UnderVolt Lv1  
Delay 1000ms <<

UnderVolt Lv2  
Point 235,0V <<

UnderVolt Lv2  
Delay 1000ms <<

UnderVolt Lv3  
Point 235,0V <<

UnderVolt Lv3  
Delay 1000ms <<

OverFreq Lv3  
Point 52,00Hz <<

OverFreq Lv3  
Delay 1000ms <<

OverFreq Lv2  
Point 52,00Hz <<

OverFreq Lv2  
Delay 1000ms <<

OverFreq Lv1  
Point 52,00Hz <<

OverFreq Lv1  
Delay 1000ms <<

UnderFreq Lv1  
Point 48,00Hz <<

UnderFreq Lv1  
Delay 1000ms <<

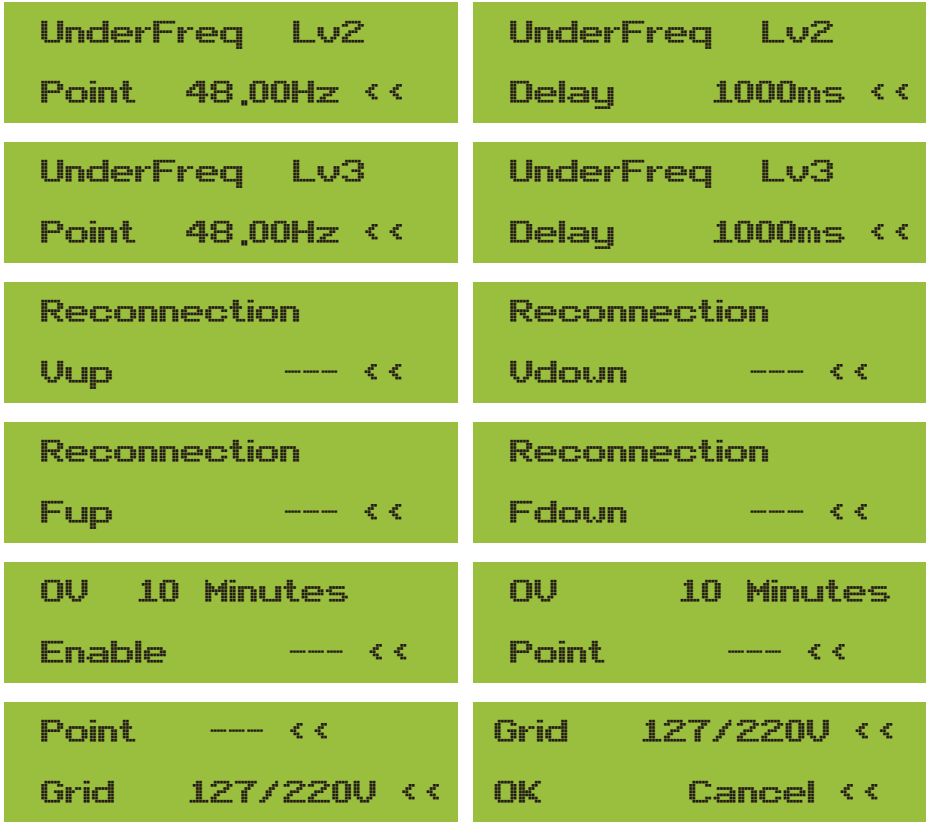

Pic 8.36 Advanced

**8.6 Comm. param setting**



Pic 8.37 Data Logger Modbus Address



Pic 8.38 The currently detected meter



**Warning:**  
Engineer only.



## 9. Repair and Maintenance

String type inverter doesn't need regular maintenance. However, debris or dust will affect heat sink's thermal performance. It is better to clean it with a soft brush. If the surface is too dirty and affect the reading of LCD and LED lamp, you can use wet cloth to clean it up.



### High Temperature Hazard:

When the device is running, the local temperature is too high and the touch can cause burns. Turn off the inverter and wait for it cooling, then you can clean and maintain.



### Safety Hint:

No solvent, abrasive materials or corrosive materials can be used for cleaning any parts of the inverter.

## 10. Error information and processing

Inverter has been designed in accordance with international grid tied standards for safety, and electromagnetic compatibility requirements. Before delivering to the customer the inverter has been subjected to several tests to ensure its optimal operation and reliability.

### 10.1 Error code

If there is any failure, the LCD screen will display an alarm message. In this case, the inverter may stop feeding energy into the grid. The alarm description and their corresponding alarm messages are listed Table 10.1.

Error code	Description	Ongrid - Single Phase
F01	DC input polarity reverse fault	Check the PV input polarity.
F02	DC insulation impedance permanent fault	Check the grounding cable of inverter.
F03	DC leakage current fault	Hardly appear the code. Never ever happened so far.
F04	Ground fault GFDI	Check the solar panel output connection.
F05	Read the memory error	Failure in reading memory (EEPROM). Restart the inverter if the fault still exists, contact your installer or Deye service.
F06	Write the memory error	Failure in writing memory (EEPROM). Restart the inverter if the fault still exists, contact your installer or Deye service.
F07	GFDI blown fuse	Hardly appear the code. Never ever happened so far.
F08	GFDI grounding touch failure	Hardly appear the code. Never ever happened so far.
F09	IGBT damaged by excessive drop voltage	Hardly appear the code. Never ever happened so far.

Error code	Description	Ongrid - Single Phase
F10	Auxiliary switch power supply failure	Hardly appear the code. Never ever happened so far.
F11	Ac main contactor errors	Hardly appear the code. Never ever happened so far.
F12	AC auxiliary contactor errors	Hardly appear the code. Never ever happened so far.
F13	Working mode changed/Grid mode changed	Hardly appear the code. Never ever happened so far.
F14	DC firmware over current	Hardly appear the code. Never ever happened so far.
F15	AC firmware over current	<ol style="list-style-type: none"> <li>1. The internal AC sensor or detection circuit on control board or connection wire may loose.</li> <li>2. Restart the inverter, if the error still exists, please contact your installer or Deye service.</li> </ol>
F16	GFCI(RCD) Ac leakage current fault	<ol style="list-style-type: none"> <li>1. This fault means the average leakage current is over 300mA. Check whether DC power supply or solar panels is ok, then check 'Test data'-&gt; 'diL' value is about 120; Then check the leakage current sensor or circuit( the following picture). Checking test data needs using big LCD.</li> <li>2. Restart the inverter, if the error still exists, please contact your installer or Deye service.</li> </ol>
F17	Three phase current, over-current fault	Hardly appear the code. Never ever happened so far.
F18	AC over current fault of hardware	<ol style="list-style-type: none"> <li>1. Check AC sensor or detection circuit on control board or connection wire.</li> <li>2. Restart the inverter or factory reset, if the error still exists, please contact your installer or Deye service.</li> </ol>
F19	All hardware failure synthesis	<ol style="list-style-type: none"> <li>1. When inverter is running, wifi plug plugin, will occur F19.</li> <li>2. Restart the inverter or factory reset, if the error still exists, please contact your installer or Deye service.</li> </ol>
F20	DC over current fault of the hardware	Not available.
F21	DC leakage flow fault	Hardly appear the code. Never ever happened so far.
F22	Crash stop (if there is a stop button)	Contact your installer for help.
F23	AC leakage current is transient over current	<ol style="list-style-type: none"> <li>1. This fault means the leakage current is above 30mA suddenly. Check whether DC power supply or solar panels is ok, then check 'Test data'-&gt; 'diL' value is about 120; Then check the leakage current sensor or circuit. Check test data needs using big LCD.</li> <li>2. Restart the inverter, if the fault still exists, contact your installer or Deye service.</li> </ol>
F24	DC insulation impedance failure	<ol style="list-style-type: none"> <li>1. Check Vpe resistance on main board or detection on control board. Check PV panels is OK. Many times this issue is the PV problem.</li> <li>2. Check whether the PV panel (aluminum frame) is grounded well and inverter is grounded well. Open the cover of inverter and then check the inside ground cable is fixed well on the shell.</li> <li>3. Check if the AC/DC cable, terminal block are shorted to ground or the insulation is damaged.</li> <li>4. Restart the inverter, if the fault still exists, contact your installer or Deye service.</li> </ol>
F25	DC feedback fault	Hardly appear the code. Never ever happened so far.
F26	The DC busbar is unbalanced	Hardly appear the code. Never ever happened so far.

Error code	Description	Ongrid - Single Phase
F27	DC end insulation error	Hardly appear the code. Never ever happened so far.
F28	Inverter 1 DC high fault	Hardly appear the code. Never ever happened so far.
F29	AC load switch failure	Hardly appear the code. Never ever happened so far.
F30	AC main contactor failure	<ol style="list-style-type: none"> <li>1. Check relays and AC voltage of relays.</li> <li>2. Check relays driver circuit.</li> <li>3. Check if the software is not suitable for this inverter. (Old inverter not have relays detection function)</li> <li>4. restart the inverter, if the fault still exists, contact your installer or Deye service.</li> </ol>
F31	Dc boost soft start	Not available.
F32	Inverter 2 dc high fault	Hardly appear the code. Never ever happened so far.
F33	AC over current	AC current sensor or its circuit have issue. Check if the inverter type is not right.
F34	AC current over load	Hardly appear the code. Never ever happened so far.
F35	No AC grid	<ol style="list-style-type: none"> <li>1. Check AC grid voltage. Check AC voltage detection circuit. Check if the AC connector in good condition. Check whether the AC grid is normal in voltage.</li> <li>2. Restart the inverter, if the fault still exists, contact your installer or Deye service.</li> </ol>
F36	AC grid phase error	Hardly appear the code. Never ever happened so far.
F37	AC three-phase voltage unbalance failure	Hardly appear the code. Never ever happened so far.
F38	AC three-phase current unbalance failure	Hardly appear the code. Never ever happened so far.
F39	AC over current(one cycle)	<ol style="list-style-type: none"> <li>1. Check AC current sensor and its circuit.</li> <li>2. Restart the inverter, if the fault still exists, contact your installer or Deye service.</li> </ol>
F40	DC over current	Hardly appear the code. Never ever happened so far.
F41	AC Line W,U over voltage	Check the AC voltage protection setting. And Check if the AC cable is too thin.Check the voltage difference between LCD and meter.
F42	AC Line W,U low voltage	Check the AC voltage protection setting. Check the voltage difference between LCD and meter. Also need to check whether AC cables are all firmly and correctly connected.
F43	AC Line V,W over voltage	Not available.
F44	AC Line V,W low voltage	Not available.
F45	AC Line U,V over voltage	Not available.
F46	AC Line U,V low voltage	Not available.
F47	AC Over frequency	Check the frequency protection setting.
F48	AC lower frequency	Check the frequency protection setting.
F49	U phase grid current DC component over current	Hardly appear the code. Never ever happened so far.
F50	V phase grid current DC component over current	Hardly appear the code. Never ever happened so far.

Error code	Description	Ongrid - Single Phase
F51	W phase grid current DC component over current	Hardly appear the code. Never ever happened so far.
F52	AC inductor A, phase current DC current high	Hardly appear the code. Never ever happened so far.
F53	AC inductor B, phase current DC current high	Hardly appear the code. Never ever happened so far.
F54	AC inductor C, phase current DC current high	Hardly appear the code. Never ever happened so far.
F55	DC busbar voltage is too high	1. Check PV voltage and Ubus voltage and its detection circuit. If the PV input voltage exceeds the limit, please reduce the number of solar panels in series. 2. For Ubus voltage, please check the LCD display.
F56	DC busbar voltage is too low	1. It tells the PV input voltage is low and it always happens in the early morning. 2. Check PV voltage and Ubus voltage. When inverter is running, then showing F56, maybe Loss of driver or need update firmware. 3. Restart the inverter, if the fault still exists, contact your installer or Deye service.
F57	AC reverse irrigation	AC reverse irrigation.
F58	AC grid U over current	Hardly appear the code. Never ever happened so far.
F59	AC grid V over current	Hardly appear the code. Never ever happened so far.
F60	AC grid W over current	Hardly appear the code. Never ever happened so far.
F61	Reactor A phase over current	Hardly appear the code. Never ever happened so far.
F62	Reactor B phase over current	Hardly appear the code. Never ever happened so far.
F63	ARC fault	1. Check PV module cable connection and clear the fault; 2. Seek help from us, if can not go back to normal state.
F64	IGBT heat sink high temperature	1. Check temperature sensor. Check if firmware is suitable for the hardware. Check if the inverter is its right model. 2. Restart the inverter, if the fault still exists, contact your installer or Deye service.

Table10.1 Error codes and their solutions



**Safety Hint:**

If your string inverter has any of the fault information shown in Table 10-1, and when you reset the machine and still don't solve the problem, please contact our distributor and provide the below details:

1. Serial number of the inverter;
2. The distributor/dealer of the inverter(if available);
3. Installation date;
4. The discription of problem(include LCD'error code and LED starus indicator lights);
5. Your contact details.

## 11.Specification

Model	SUN-3.6K- G05P1-EU-AM2	SUN-4K- G05P1-EU-AM2	SUN-4.2K- G05P1-EU-AM2	SUN-4.6K- G05P1-EU-AM2
<b>PV String Input Data</b>				
Max. PV Input Power(kW)	4.7	5.2	5.5	6.0
Max. PV Input Voltage(V)	550			
Start-up Voltage(V)	80			
PV Input Voltage Range(V)	80-550			
MPPT Voltage Range(V)	70-500			
Rated PV Input Voltage(V)	360			
Full Load MPPT Voltage Range(V)	130-500	145-500	150-500	165-500
Max. Input Short Circuit Current (A)	27+27			
Max. Operating PV Input Current(A)	18+18			
No. of MPP Trackers/No. of Strings per MPP Tracker	2/1+1			
Max. Inverter Backfeed Current To the Array	0			
<b>AC Output Data</b>				
Rated AC Output Active Power(kW)	3.6	4	4.2	4.6
Max.AC Output Apparent Power(kVA)	3.96	4.4	4.62	5.06
Rated AC Output current (A)	16.4/15.7	18.2/17.4	19.1/18.3	21.0/20.0
Max.AC Output Current(A)	18.0/17.3	20.0/19.2	21.0/20.1	23.0/22.0
Max. Output Fault Current(A)	31.4	34.8	36.6	40
Max. Output Overcurrent Protection(A)	75			
Rated Output voltage/range (V)	220/230V 0.85Un-1.1Un			
Grid Connection Form	L+N+PE			
Rated Output Grid Frequency/range(Hz)	50Hz/45Hz-55Hz, 60Hz/55Hz-65Hz			
Power Factor Adjustment Range	0.8 leading-0.8lagging			
Total Current Harmonic Distortion THDi	<3%			
DC Injection Current	<0.5%In			
<b>Efficiency</b>				
Max.Efficiency	97.3%			97.5%
Euro Efficiency	96.9%			97.0%
MPPT Efficiency	>99%			
<b>Equipment Protection</b>				
DC Polarity Reverse Connection Protection	yes			
AC Output Overcurrent Protection	yes			
AC Output Overvoltage Protection	yes			
AC Output Short Circuit Protection	yes			
Thermal Protection	yes			
DC Terminal Insulation Impedance Monitoring	yes			
DC component monitoring	yes			
Ground fault current monitoring	yes			
Power Network Monitoring	yes			
Island protection monitoring	yes			
Earth Fault Detection	yes			
DC Input Switch	yes			
Overvoltage Load Drop Protection	yes			
Residual Current (RCD) Detection	yes			
Surge Protection Level	TYPE II(DC), TYPE II(AC)			

<b>Interface</b>	
Communication Interface	RS485/RS232
Monitor Mode	GPRS/WIFI/Bluetooth/4G/LAN (optional)
Display	LCD+LED
<b>General Data</b>	
Operating Temperature Range (°C)	-25 to +60°C, >45°C derating
Permissible Ambient Humidity	0-100%
Permissible Altitude (m)	3000m
Noise (dB)	≤ 35dB
Ingress Protection(IP) Rating	IP 65
Inverter Topology	Non-Isolated
Over Voltage Category	OVC II(DC),OVC III(AC)
Cabinet Size (W*H*D) [mm]	305×280×180 (Excluding connectors and brackets)
Weight [kg]	7.7
Warranty [year]	Standard 5 years, extended warranty
Type Of Cooling	Natural cooling
Grid Regulation	IEC 61727, IEC 62116, CEI 0-21, EN 50549, NRS 097, RD 140, UNE 217002, G99, VDE-AR-N 4105
Safety EMC/Standard	IEC/EN 61000-6-1/2/3/4, IEC/EN 62109-1, IEC/EN 62109-2

Model	SUN-5K- G05P1-EU-AM2	SUN-5.2K- G05P1-EU-AM2	SUN-6K- G05P1-EU-AM2	SUN-6.2K- G05P1-EU-AM2
<b>PV String Input Data</b>				
Max. PV Input Power(kW)	6.5	6.8	7.8	8.1
Max. PV Input Voltage(V)	550			
Start-up Voltage(V)	80			
PV Input Voltage Range(V)	80-550			
MPPT Voltage Range(V)	70-500			
Rated PV Input Voltage(V)	360			
Full Load MPPT Voltage Range(V)	180-500	190-500	215-500	225-500
Max. Input Short Circuit Current (A)	27+27			
Max. Operating PV Input Current(A)	18+18			
No. of MPP Trackers/No. of Strings per MPP Tracker	2/1+1			
Max. Inverter Backfeed Current To the Array	0			
<b>AC Output Data</b>				
Rated AC Output Active Power(kW)	5	5.2	6	6.2
Max.AC Output Apparent Power(kVA)	5.5	5.72	6.6	6.82
Rated AC Output current (A)	22.8/21.8	23.7/22.7	27.3/26.1	28.2/27.0
Max.AC Output Current(A)	25.0/24.0	26.0/24.9	30.0/28.7	31.0/29.7
Max. Output Fault Current(A)	43.6	45.4	52.2	54
Max. Output Overcurrent Protection(A)	75			
Rated Output voltage/range (V)	220/230V 0.85Un-1.1Un			
Grid Connection Form	L+N+PE			
Rated Output Grid Frequency/range(Hz)	50Hz/45Hz-55Hz, 60Hz/55Hz-65Hz			
Power Factor Adjustment Range	0.8 leading-0.8lagging			
Total Current Harmonic Distortion THDi	<3%			
DC Injection Current	<0.5%In			
<b>Efficiency</b>				
Max.Efficiency	97.5%			
Euro Efficiency	97.0%			
MPPT Efficiency	>99%			
<b>Equipment Protection</b>				
DC Polarity Reverse Connection Protection	yes			
AC Output Overcurrent Protection	yes			
AC Output Overvoltage Protection	yes			
AC Output Short Circuit Protection	yes			
Thermal Protection	yes			
DC Terminal Insulation Impedance Monitoring	yes			
DC component monitoring	yes			
Ground fault current monitoring	yes			
Power Network Monitoring	yes			
Island protection monitoring	yes			
Earth Fault Detection	yes			
DC Input Switch	yes			
Overvoltage Load Drop Protection	yes			
Residual Current (RCD) Detection	yes			
Surge Protection Level	TYPE II(DC),TYPE II(AC)			

<b>Interface</b>	
Communication Interface	RS485/RS232
Monitor Mode	GPRS/WIFI/Bluetooth/4G/LAN (optional)
Display	LCD+LED
<b>General Data</b>	
Operating Temperature Range (°C)	-25 to +60°C, >45°C derating
Permissible Ambient Humidity	0-100%
Permissible Altitude (m)	3000m
Noise (dB)	≤ 35dB
Ingress Protection(IP) Rating	IP 65
Inverter Topology	Non-Isolated
Over Voltage Category	OVC II(DC), OVC III(AC)
Cabinet Size (W*H*D) [mm]	305×280×180 (Excluding connectors and brackets)
Weight [kg]	7.7
Warranty [year]	Standard 5 years, extended warranty
Type Of Cooling	Natural cooling
Grid Regulation	IEC 61727, IEC 62116, CEI 0-21, EN 50549, NRS 097, RD 140, UNE 217002, G99, VDE-AR-N 4105
Safety EMC/Standard	IEC/EN 61000-6-1/2/3/4, IEC/EN 62109-1, IEC/EN 62109-2

## 12. EU Declaration of Conformity

within the scope of the EU directives

- Electromagnetic compatibility 2014/30/EU (EMC)
- Low Voltage Directive 2014/35/EU (LVD)
- Restriction of the use of certain hazardous substances 2011/65/EU (RoHS)



NINGBO DEYE INVERTER TECHNOLOGY CO., LTD. confirms herewith that the products described in this document are in compliance with the fundamental requirements and other relevant provisions of the above mentioned directives. The entire EU Declaration of Conformity and certificate can be found at <https://www.deyeinverter.com/download/#string-inverter>.



## EU Declaration of Conformity

Product: **Grid-connected PV Inverter**

Models: SUN-3.6K-G05P1-EU-AM2;SUN-4K-G05P1-EU-AM2;SUN-4.2K-G05P1-EU-AM2;SUN-4.6K-G05P1-EU-AM2;  
SUN-5K-G05P1-EU-AM2;SUN-5.2K-G05P1-EU-AM2;SUN-6K-G05P1-EU-AM2;SUN-6.2K-G05P1-EU-AM2;

Name and address of the manufacturer: Ningbo Deye Inverter Technology Co., Ltd.

No. 26 South YongJiang Road, Daqi, Beilun, NingBo, China

This declaration of conformity is issued under the sole responsibility of the manufacturer. Also this product is under manufacturer's warranty.

This declaration of conformity is not valid any longer: if the product is modified, supplemented or changed in any other way, as well as in case the product is used or installed improperly.

The object of the declaration described above is in conformity with the relevant Union harmonization legislation: The Low Voltage Directive (LVD) 2014/35/EU;the Electromagnetic Compatibility (EMC) Directive 2014/30/EU;the restriction of the use of certain hazardous substances (RoHS) Directive 2011/65/EU.

References to the relevant harmonized standards used or references to the other technical specifications in relation to which conformity is declared:

<b>LVD:</b>	
EN 62109-1:2010	●
EN 62109-2:2011	●
<b>EMC:</b>	
EN IEC 61000-6-1:2019	●
EN IEC 61000-6-2:2019	●
EN IEC 61000-6-3:2021	●
EN IEC 61000-6-4:2019	●
EN IEC 61000-3-2:2019+A1:2021	●
EN 61000-3-3:2013/A2:2021/AC:2022-01	●
EN IEC 61000-3-11:2019	●
EN 61000-3-12:2011	●
EN 55011:2016/A2:2021	●
EN 62920:2017/A1:2021	●

**Nom et Titre / Name and Title:**

Bard Dai  
Senior Standard and Certification Engineer

宁波德业技术有限公司

Ningbo Deye Inverter Technology Co., Ltd.

2023-12-23

Ningbo, China

**Au nom de / On behalf of:**

**Date / Date (yyyy-mm-dd):**

**A / Place:**

EU DoC – vZ

Ningbo Deye Inverter Technology Co., Ltd.  
No. 26 South YongJiang Road, Daqi, Beilun, NingBo, China

## NINGBO DEYE INVERTER TECHNOLOGY CO., LTD.

Add. : No.26 South YongJiang Road, Daqi, Beilun, NingBo, China.

Tel. : +86 (0) 574 8622 8957

Fax. : +86 (0) 574 8622 8852

E-mail : [service@deye.com.cn](mailto:service@deye.com.cn)

Web. : [www.deyeinverter.com](http://www.deyeinverter.com)



30240301002864